

Nokia 6275i User's Guide



Copyright ©2006 Nokia. All rights reserved.

Nokia, Nokia Connecting People, Pop-Port, Nokia 6275i, and the Nokia Original Enhancements logos are trademarks or registered trademarks of Nokia Corporation. Other company and product names mentioned herein may be trademarks or trade names of their respective owners. Copyright protections may prevent some images, music (including ringing tones), and the content from being copied, modified, transferred, or forwarded.

US Patent No 5818437 and other pending patents. T9 text input software Copyright ©1999-2006. Tegic Communications, Inc. All rights reserved.



Bluetooth wireless technology is a registered trademark of Bluetooth SIG, Inc.



MicroSD is a registered trademark of the SD Card Association.



Includes RSA BSAFE cryptographic or security protocol software from RSA Security.



Java is a trademark of Sun Microsystems, Inc.

The information contained in this user guide was written for the Nokia 6275i products. Nokia operates a policy of ongoing development. Nokia reserves the right to make changes to any of the products described in this document without prior notice.

UNDER NO CIRCUMSTANCES SHALL NOKIA BE RESPONSIBLE FOR ANY LOSS OF DATA OR INCOME OR ANY SPECIAL, INCIDENTAL, AND CONSEQUENTIAL OR INDIRECT DAMAGES HOWSOEVER CAUSED. THE CONTENTS OF THIS DOCUMENT ARE PROVIDED "AS IS." EXCEPT AS REQUIRED BY APPLICABLE LAW, NO WARRANTIES OF ANY KIND, EITHER EXPRESS OR IMPLIED, INCLUDING, BUT NOT LIMITED TO, THE IMPLIED WARRANTIES OF MERCHANTABILITY AND FITNESS FOR A PARTICULAR PURPOSE, ARE MADE IN RELATION TO THE ACCURACY AND RELIABILITY OR CONTENTS OF THIS DOCUMENT. NOKIA RESERVES THE RIGHT TO REVISE THIS DOCUMENT OR WITHDRAW IT AT ANY TIME WITHOUT PRIOR NOTICE.

EXPORT CONTROLS This device may contain commodities, technology, or software subject to export laws and regulations from the U.S. and other countries. Diversion contrary to law is prohibited.

Contents

For your safety	vii	Make calls.....	10
Network services.....	viii	Answer or reject a call	10
About your device	viii	Call waiting	11
Shared memory	ix	Mute phone during call.....	11
		Options during a call.....	11
		Make a conference call	11
		Keypad lock (keyguard).....	12
Welcome	x	3. Text entry	13
Getting help	x	Standard mode.....	13
Find your phone label	x	Text (Abc)	13
Nokia support and contact		Numbers (123)	13
information	x	Punctuation and special	
		characters.....	13
		Predictive text mode	13
		Activate or deactivate	14
		Text entry	14
		Change case and mode.....	14
1. Phone at a glance	1	4. Messages	15
Keys and parts	1	Create distribution lists	15
Front view	1	Add and remove contacts.....	16
Side views.....	1	Manage distribution lists.....	16
Standby mode.....	2	Text messages.....	16
Quick keys.....	2	Write and send	16
Indicators and icons	2	Read message	17
Phone menus	2	Reply to message	17
Scroll method.....	3	Templates	18
Main menu display	3	Text message folders.....	18
Go to functions.....	3	Delete messages.....	19
In-phone help.....	4	Sending options.....	20
Security code settings.....	4	Other settings	20
		Voice messages	21
		Save voice mailbox number.....	21
		Set up voice mail	21
		Listen to voice messages	21
		Automate voice mail.....	21
		Clear voice mail icon.....	22
2. Set up your phone	5		
Antenna.....	5		
Battery.....	6		
Remove the back cover	6		
Remove the battery.....	6		
MicroSD card.....	7		
UIM (CDMA SIM) card			
installation.....	7		
Replace the battery	8		
Replace the back cover	8		
Charge the battery.....	9		
Turn your phone on or off.....	9		
Connect the headset	9		

Web messaging	23	Media player	36
5. Log	24	Music player.....	36
View missed calls.....	24	Play music tracks	37
View received calls.....	24	Music player options.....	37
View dialled numbers.....	24	Radio	37
View message recipients	25	Save radio channels.....	38
Clear log lists	25	Listen to the radio.....	38
Call duration	25	Voice recorder	39
Data or fax calls.....	25	Record speech or sound	39
Duration of minibrowser calls	26	Equaliser.....	39
		Activate an equaliser set	39
		Create a custom equaliser set.....	39
6. Contacts	27	9. Settings	40
Add new contacts.....	27	Profiles.....	40
Save contact name and number..	27	Personalise a profile.....	40
Save contact number only.....	27	Set a timed profile.....	40
Save an entry	27	Display	41
Save numbers and text items.....	27	Standby mode settings.....	41
Change default number	28	Screen saver	41
Caller groups	28	Sleep mode	41
Set up Speed dials	28	Backlight time-out	41
Voice tags	29	Themes.....	42
Assign a voice tag to an entry	29	Tone settings.....	42
Dial a number.....	29	Time and date settings.....	42
Voice tags.....	30	Clock.....	42
Edit contacts list entries.....	30	Date.....	43
Delete contacts entries.....	31	Date and time auto-update	43
Access the contacts menu	31	Call settings	43
Search for a name.....	31	Anykey answer.....	43
Configure settings	31	Automatic redial	43
Send and receive contacts.....	31	Speed dialling.....	43
Send a business card.....	31	Automatic service update.....	43
		Calling cards.....	44
7. Gallery	33	International prefix	45
Folders	33	Data or fax calls	45
Fun frames and clip art.....	34	Call summary	45
		Show call time	45
8. Media.....	35	Ringtone for no caller ID	45
Camera	35	Phone settings.....	46
Take a photo.....	35	Language settings.....	46
Record a video clip	35	Automatic keyguard.....	46
Camera options.....	35		

Navigation key	46	Notes	62
Memory status	46	Send a note	63
DTMF tones	46	Notes options	63
Start-up tone	47	To-do list	63
Help text activation	47	Send a to-do list note	65
Voice commands and voice tags ...	47	To-do list options	65
Hands-free operation	48	Calculator	65
Connectivity	48	Currency converter	66
Bluetooth connectivity	49	Timers	66
Infrared connectivity	52	Normal timer	66
Data cable transfer	52	Interval timer	67
Enhancements	54	Stopwatch	68
Security	54	Measure split or lap time	68
PIN code	54	Save a time	68
PIN code request	55	Stopwatch options	69
Call restrictions	55	Operation note	69
Security level	55		
Access codes	56	11. Minibrowser	70
Voice privacy	56	Mobile internet access	70
Personal unblocking key (PUK) code	56	Sign on to the mobile internet	71
Application settings	57	Navigate the mobile internet	71
Network	57	Phone keys	71
Network services	57	Receive a call while online	71
Positioning	57	Make an emergency call while online	71
Restore factory settings	58	Clear the cache and disconnect..	72
Phone details	58		
		12. Extras	73
10. Organiser	59	Memory card	73
Alarm clock	59	Games	73
Set an alarm	59	Collection	73
Repeat alarm	59	Launch an application	73
Set the alarm tone	59		
Set the snooze time-out	60	13. PC connectivity	74
Calendar	60	PC data transfer	74
Open calendar	60	Nokia PC Suite	74
Calendar options	60		
Make a calendar note	61	14. Enhancements	75
View calendar notes (day view) ...	61		
Options while viewing a day	61	15. Battery information	77
Receive a calendar note	62	Charging and discharging	77
Modify calendar settings	62	Nokia battery authentication	

guidelines.....	78
16. Care and maintenance	80
17. Additional safety information	81
Operating environment.....	81
Medical devices.....	81
Vehicles	82
Potentially explosive environments	82
Emergency calls	83
Certification information (SAR).....	83
Index	86

For your safety

Read these simple guidelines. Not following them may be dangerous or illegal. Read the complete user guide for further information.



SWITCH ON SAFELY

Do not switch the phone on when wireless phone use is prohibited or when it may cause interference or danger.



ROAD SAFETY COMES FIRST

Obey all local laws. Always keep your hands free to operate the vehicle while driving. Your first consideration while driving should be road safety.



INTERFERENCE

All wireless phones may be susceptible to interference, which could affect performance.



SWITCH OFF IN HOSPITALS

Follow any restrictions. Switch the phone off near medical equipment.



SWITCH OFF IN AIRCRAFT

Follow any restrictions. Wireless devices can cause interference in aircraft.



SWITCH OFF WHEN REFUELLING

Do not use the phone at a refuelling point. Do not use near fuel or chemicals.



SWITCH OFF NEAR BLASTING

Follow any restrictions. Do not use the phone where blasting is in progress.



USE SENSIBLY

Use only in the normal position as explained in the product documentation. Do not touch the antenna unnecessarily.



QUALIFIED SERVICE

Only qualified personnel may install or repair this product.



ENHANCEMENTS AND BATTERIES

Use only approved enhancements and batteries. Do not connect incompatible products.



WATER-RESISTANCE

Your phone is not water resistant. Keep it dry.



BACKUP COPIES

Remember to make back-up copies or keep a written record of all important information stored in your phone.



CONNECTING TO OTHER DEVICES

When connecting to any other device, read its user guide for detailed safety instructions. Do not connect incompatible products.



EMERGENCY CALLS

Ensure the phone is switched on and in service. Press the end key as many times as needed to clear the display and return to standby mode. Enter the emergency number, then press the call key. Give your location. Do not end the call until given permission to do so.

■ Network services

To use the phone you must have service from a wireless service provider or network operator. Many of the features in this device depend on features in the wireless network to function. These network services may not be available on all networks or you may have to make specific arrangements with your service provider before you can utilise network services. Your service provider may need to give you additional instructions for their use and explain what charges will apply. Some networks may have limitations that affect how you can use network

services. For instance, some networks may not support all language-dependent characters and services.

Your service provider may have requested that certain features be disabled or not activated in your device. If so, they will not appear on your device menu. Your device may also have been specially configured. This configuration may include changes in menu names, menu order and icons. Contact your service provider for more information.

This device supports WAP 2.0 protocols (HTTP and SSL) that run on TCP/IP protocols. Some features of this device, such as *Minibrowser* require network support for these technologies.

■ About your device

The wireless devices described in this guide are approved for use on the CDMA 800 and 1900, AMPS networks, and GPS in the Nokia 6275i device. Contact your network operator for more information about networks.



Note: The Nokia 6275i GPS Application is a simple and convenient navigation system. It is not enabled for emergency services use and is not able to indicate your specific location to emergency services in the event of an emergency.

When using the features in this device, obey all laws and respect privacy and legitimate rights of others. When taking and using images or video clips, obey all laws and respect local customs as well as privacy and legitimate rights of others.



Warning: To use any features in this device, other than the alarm clock, the device must be switched on. Do not switch the device on when wireless device use may cause interference or danger.

■ Shared memory

The following device features may share memory: contacts; text messages; photos, images, and tones in the gallery; calendar notes; games; and applications. Use of one or more of these features may reduce the memory available for the remaining features sharing memory. If your phone displays a message that the memory is full when you try to use a shared memory feature, delete some of the information or entries stored in the shared memory features before continuing. Some of the features, such as photos, images, and tones in the gallery; text messages; and applications may have a certain amount of memory specially allotted to them in addition to the memory shared with other features.

Welcome

Congratulations on your purchase of the Nokia mobile phone. Your phone provides many functions which are practical for daily use, such as a hands-free loudspeaker, camera, MP3 player, video recorder, and more. Your phone can also connect to a PC, laptop, or other device using a USB data cable, Bluetooth wireless technology, or infrared.

■ Getting help

Check www.nokia-asia.com/6275i/support or your local Nokia Web site for the latest version of this guide, additional information, downloads, and services related to your Nokia product.

Find your phone label

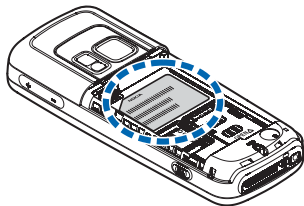

If you need help, the Nokia Care Contact Center is available for assistance. Before calling, we recommend that you write down the Electronic serial number (ESN) or

Mobile Equipment ID (MEID) and have it available.

The ESN or MEID is found on the type label, which is located beneath the battery on the back of the phone. See "[Remove the back cover](#)", p. 6 and "[Remove the battery](#)", p. 6.

Nokia support and contact information

For the latest version of this guide, downloads, services and additional information related to your Nokia product, please visit www.nokia-asia.com/6275i/support or your local Nokia web site.

Should you still require assistance, please refer to www.nokia-asia.com/contactus.

To check for the nearest Nokia care center location for maintenance services, you may like to visit www.nokia-asia.com/repair.

1. Phone at a glance

■ Keys and parts

Front view

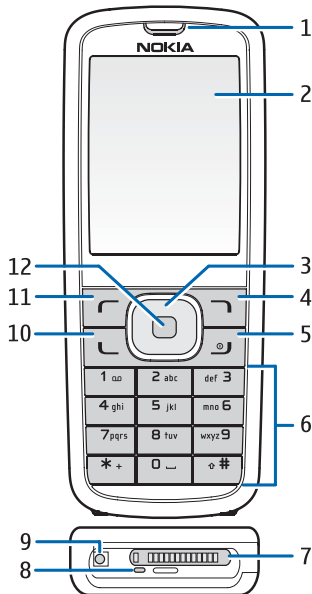

- Earpiece (1)
- Display (2)
- Scroll key (3)
- Right selection key (4)
- End and power key (5)
- Keypad (6)
- Pop-Port™ connector (7)

- Microphone (8)
- Charger port (9)
- Call key (10)
- Left selection key (11)
- Center selection key (12)

Side views

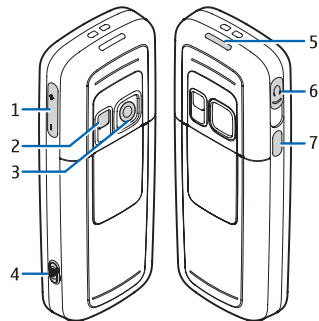

- Volume key (1)
- Camera flash and self-portrait mirror (2)
- Camera lens (3)
- Camera key (4)
- Loudspeaker (5)
- Headset connector (6)
- Infrared (7)

■ Standby mode

Depending on your wireless service provider or network operator and the model number of your phone, some or all of the following selection keys may appear in standby mode.

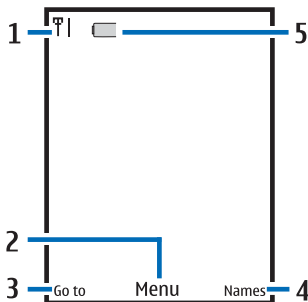

The standby mode indicates that your phone is idle.

Signal strength (1)—More bars indicate a stronger network signal.

Menu (2)—Press the center selection key to select this option.

Go to (3)—Press the left selection key to select this option.

Names or network operator menu (4)—Press the right selection key to select this option.

Battery level (5)—A filled in battery indicates more power.

■ Quick keys

Depending on your wireless service provider or network operator and the model number of your phone, some or all of the following scroll key shortcuts may be available in standby mode.

In standby mode, the four-way scroll and center selection keys instantly take you to frequently-accessed menus:

Scroll up key—Go to the camera.

Scroll right key—View the calendar.

Scroll down key—Go to the contacts list.

Scroll left key—Create a text message.

Center selection key—Display available applications or selects highlighted menus and submenus.

■ Indicators and icons

To view the icons on your phone, select *Menu > Settings > Phone details > Icon details*.

■ Phone menus

Phone features are grouped according to function and are accessed through the main menus. Each main menu contains submenus and lists from which you can select or view items and personalise your phone features. You can access these menus and submenus by using the scroll method or by using a shortcut.



Note: Some features may not be available, depending on your network. For more information, contact your wireless provider.

Scroll method

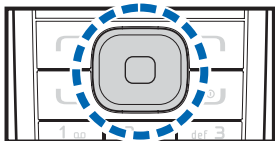

1. To select *Menu*, use the center selection key. To scroll through the main menu, use the scroll key.

On the right side of the screen, a scroll bar is displayed with a tab that moves up or down as you move through the menus. This provides a visual representation of your current position in the menu structure.

2. When you arrive at a menu, to enter submenus, press *Select* (the center selection key).

To return to the previous menu, select *Back* from the submenu level.

To return to standby mode from any menu or submenu, press the end key.

Main menu display

You can control whether your phone menu is displayed as a *List*, *Grid* or *Grid with labels*. By default, the main menu displays in *Grid with labels* format.

Select *Menu > Options > Main menu view > List, Grid, or Grid with labels*.

If supported by your wireless service provider or network operator, you can also change the order of menus in your main menu.

Select *Menu > Options > Organise*. Scroll to a menu, and select *Move*.

Use the scroll key to move the menu to a new location, and select *OK*. You can repeat this procedure to personalise your main menu.

To save the changes, select *Done > Yes*.

Go to functions

The *Go to* menu allows you to change the function of the left selection key on your phone so that your most frequently used functions can be quickly accessed from the *Go to* menu in standby mode.

Select options

1. Select *Go to > Options > Select options*, and scroll to the options you want to add.
2. Select *Mark* to add an option or *Unmark* to remove an option.

3. When you have marked or unmarked the desired options, select *Done*; to save the changes, select *Yes*.
4. Select *Go to* to display a list of the options that you selected in step 3.

Organise functions

Select *Go to* > *Options* > *Organise*.

Scroll to an option, and select *Move*.

Scroll to move the option to a new location, and select *OK*. You can repeat this procedure to personalise your *Go to* menu.

To save the changes, select *Done* > *Yes*.

In-phone help

Many features have brief descriptions (help text) that can be viewed on the display. To view these descriptions, scroll to a feature, and wait for about 15 seconds. Scroll down to view all of the description, or select *Back* to exit.

In order to view the descriptions, you must activate help text. Select *Menu* > *Settings* > *Phone* > *Help text activation*.

■ Security code settings

Your device has a security option allowing you to lock your phone with a PIN code. When the PIN code is set and turned on, no outgoing calls are allowed and the menu cannot be

accessed without entering the correct code first. This prevents unauthorised outgoing calls or access to any information stored on your device.

The PIN code option is in the *Settings* menu. The first time you access the Security option, you must enter a PIN code. The default PIN code may vary depending on your wireless service provider or network operator who provided your UIM card.

The PIN code protects the UIM card from unauthorised access. The PIN code can be 4–8 digits in length. After three successive incorrect entries, the PIN code is blocked. You need to enter the personal unblocking key (PUK) code.

See "[Personal unblocking key \(PUK\) code](#)", p. 56.

2. Set up your phone

■ Antenna

Your device has an internal antenna. Hold the device as you would any other telephone with the antenna area pointed up and over your shoulder.



In the Nokia 6275i phone, the GPS antenna is internal and is activated when placing emergency calls or when On is selected from the Location info sharing menu (a carrier dependent feature).



Note: The Nokia 6275i GPS Application is a simple and convenient navigation system. It is not enabled for emergency services use and is not able to indicate your specific location to emergency services in the event of an emergency.



Note: As with any other radio transmitting device, do not touch the antenna unnecessarily when the device is switched on. Contact with the antenna affects call quality and may cause the device to operate at a higher power level than otherwise needed. Avoiding contact with the antenna area when operating the device optimises the antenna performance and the battery life.

Battery

Always switch off the power and disconnect the charger before removing the battery. Avoid touching electronic components while changing the covers. Always store and use the device with the covers attached.

Prolonged, continuous use of your device may increase the device temperature. The increased temperature is a normal function of this product and does not pose a safety concern for you or the device. If the temperature is uncomfortable to you, use a headset or allow your device to return to room temperature before your next call.

Remove the back cover

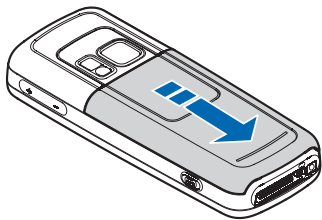

Note: Always switch off the power, and disconnect the charger and any other device before removing the cover. Avoid touching electronic components while changing the cover. Always store and use the device with the cover attached.

1. With the back of the phone facing you, press down and hold the back cover.
2. Slide the back cover toward the bottom of the phone, lift up, and remove.

Remove the battery

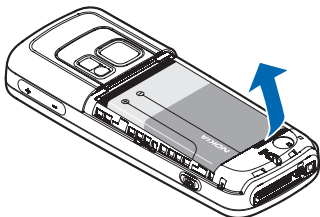

After you have removed the back cover, insert your finger into the finger grip, and lift the battery from its compartment.

Always switch the device off, and disconnect the charger before removing the battery.

MicroSD card

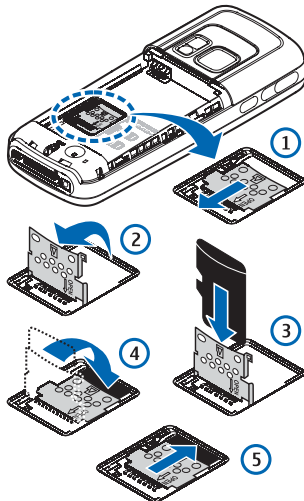

Your phone has a microSD card slot located under the battery. To insert the microSD card, complete the following steps.

Keep all microSD cards out of the reach of small children.

1. Remove the battery. Slide the microSD slot cover toward the base of the phone (1), and lift open the microSD slot cover (2).
2. Insert the card firmly as shown in the illustration (3), and close the microSD slot cover (4).

3. Slide the microSD slot cover toward the top of the phone (5), and replace the battery and back cover.



Note: Use only microSD cards approved by Nokia for use with this device. Nokia utilizes the approved industry standards for memory cards, but not all other brands may function correctly or be fully compatible with this device.



Important: Do not remove the memory card while reading or writing to the card. Doing so may cause data corruption on the card or the phone.

UIM (CDMA SIM) card installation

The User Identity Module (UIM), also called the CDMA Subscriber Identity Module (SIM), card and its contacts can be easily damaged by scratches or bending, so be careful when handling, inserting, or removing the card. The UIM card slot is built into the mechanics, located under the battery.

Before installing the UIM card, always make sure that the phone is switched off and that you have removed the cover and battery.

Set up your phone

Keep all UIM cards out of the reach of small children.

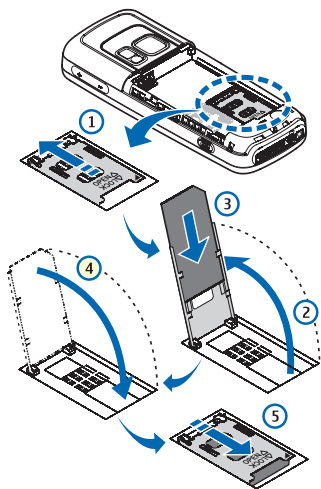

1. Slide the UIM holder in the direction of the arrow (1) to unlock.
2. Pivot the holder up (2).
3. Insert the UIM card into the holder (beveled corner last) with the gold-coloured contacts facing down, matching up with the gold-coloured contacts on the phone (3).
4. Pivot the holder down (4), slide the holder forward to lock (5), and replace the battery.

Replace the battery

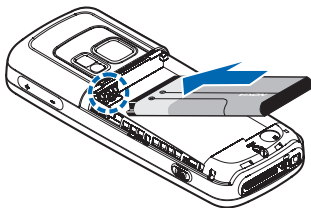

1. Insert the battery, gold-coloured contact end first, into the battery slot.
2. Push down on the other end of the battery to snap the battery into place.

Replace the back cover

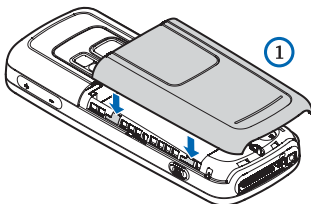

1. Set the back cover on the phone with the cover tabs aligned to the slots in the phone.

2. Press the back cover latch down, and slide the back cover toward the top of phone.

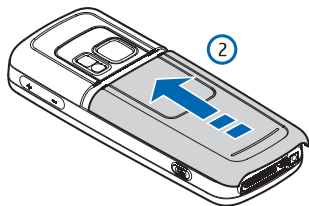

3. Make sure back cover latch is secure.

Charge the battery

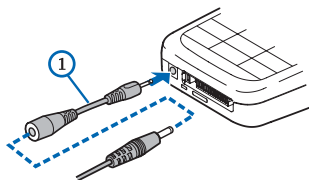

1. Plug the charger transformer into a standard wall outlet.
2. Connect the charger to the phone.

If necessary, you can use a CA-44 adapter cable (1) to connect a charger and the phone.

After a few seconds, the battery indicator in the display scrolls.

If the battery is completely discharged, it may take a few minutes before the charging indicator appears on the display or before any calls can be made.

Turn your phone on or off

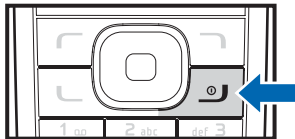

1. To turn your phone on or off, press and hold the end key for at least 3 seconds.
2. Enter the lock code, if necessary, and select **OK**.

Connect the headset

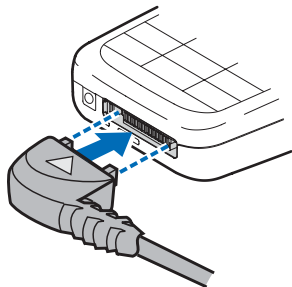

A compatible headset, such as HS-5, may be included with your phone or purchased separately as an enhancement. See "[Enhancements](#)", p. 54.

1. Plug the headset connector into the Pop-Port™ connector at the bottom end of your phone.  appears on the display.
2. Position the headset on your ear.

With the headset connected, you can make, answer, and end calls as usual.

Use the keypad to enter numbers.

Press the call key to place a call.

Press the end key to end a call.

You can also plug a compatible headset into the 2.5-mm stereo headset jack on the side of your phone to allow hands-free operation.

See "Enhancements", p. 54.



Warning: When you use the headset, your ability to hear outside sounds may be affected. Do not use the headset where it can endanger your safety.

■ Make calls

1. Enter the phone number, including the area code.

For international calls, press * twice for the international prefix (the + character replaces the international access code) and then enter the country code, the area code without the leading 0, if necessary, and the phone number.

2. To call the number, press the call key.
3. To end the call or to cancel the call attempt, press the end key.

To make a call using names, search for a name or phone number in *Contacts*. Press the call key to call the number.

To access the list of up to 20 numbers you last called or attempted to call, press the call key once in standby mode. To call the number, select a number or name, and press the call key.

■ Answer or reject a call

To answer an incoming call, press the call key. To end the call, press the end key.

To reject an incoming call, press the end key.

To mute the ringing tone, press the volume key, or select *Silence*.

To adjust the volume of the earpiece, press the volume key located on the right side of your phone. See "Side views", p. 1. A bar chart is displayed indicating the volume level.



Note: If the *Divert if busy* function is activated to forward the calls (for example, to your voice mailbox) rejecting an incoming call also forwards the call.

Call waiting

If your network operator supports this feature, call waiting notifies you of an incoming call even while you are in a call. You can then accept, reject, or ignore the incoming call.

1. Select *Menu* > *Settings* > *Network services* > *Call waiting* > *Activate* or *Cancel*.
2. During a call, select *Answer*, or press the call key or voice key to answer the waiting call. The first call is put on hold.
3. Press the end key to end the active call.

Mute phone during call

To mute your phone during a call, select *Mute*; to unmute the phone, select *Unmute*.

Options during a call

Many of the options that you can use during a call, are network services. Check with your wireless service provider or network operator for more information.

During a call, select *Options* and one of the following:

Loudspeaker or *Handset*—Activate or deactivate the loudspeaker while in a call.

Add new call—Initiate a conference call. See “[Make a conference call](#)”, p. 11.

Save—Save a number entered during a call.

Add to contact—Add a number entered during a call to a contact in your list.

End all calls—Disconnect from all active calls.

Send DTMF—Enter the numbers, and select *DTMF* to send the numbers as tones.

Contacts—View the contacts list.

Menu—View the phone menu.



Warning: Do not hold the device near your ear when the loudspeaker is in use because the volume may be extremely loud.

Make a conference call

Conference calling is a network service that allows you to take part in a conference call with two other participants.

1. Make a call to the first participant.
2. With the first participant on the line, select *Options* > *Add new call*.
3. Enter the phone number of the second participant; or to retrieve a number from your contacts, select *Search* and the number you want to call.

4. Press the call key. The first participant is put on hold.
5. When the second participant picks up, press the call key to connect the calls.
6. To end the conference call, press the end key.

■ Keypad lock (keyguard)

To prevent the keys from being accidentally pressed, select *Menu*, and press * within 3.5 seconds to lock the keypad.

To unlock the keypad, select *Unlock*, and press *. If keyguard is on, enter the security code if requested.

To answer a call when keyguard is on, press the call key. When you end or reject the call, the keypad automatically locks.

When keyguard is on, calls may be possible to the official emergency number programmed into your device.

3. Text entry

You can use two methods for entering text and numbers: standard mode and predictive text mode. Select *Clear* to backspace the cursor and delete a character. Select and hold *Clear* to backspace continuously and delete characters.

■ Standard mode

Standard mode is the only way to enter text into the contacts list and to rename caller groups.

Text (Abc)

- Press a key once to insert the first letter on the key, twice for the second letter, etc. If you pause briefly, the last letter in the display is accepted and your device awaits the next entry.
- Press 0 to enter a space, thereby accepting a completed word.
- Press 1 to insert a period into your message.
- Press * to display a complete list of special characters.
- Press and hold # to bring up the *Editor settings (Number mode, Prediction on or Prediction off, Writing language)*.

Numbers (123)

To switch to 123 mode from Abc mode, press and hold # at any message entry screen to bring up the *Editor settings*. Select *Number mode*, and the device returns to the message entry screen and switches the Abc icon in the upper left corner of the display to the 123 icon (or back).

Punctuation and special characters

While at any text entry screen, press * to display special characters (press and hold * if predictive text is on). Press * again to cycle through all available characters. Scroll to navigate through the list of special characters. With a character highlighted, select *Use* to insert the character into your message.

■ Predictive text mode

Much faster than the standard mode method, predictive text input enables you to write messages quickly using your keypad and the built-in dictionary. In predictive text mode, your phone predicts the words as you enter them.

Activate or deactivate

- At any text entry screen, select *Options > Prediction on* to activate or *Prediction off* to deactivate.
- If you are turning predictive text on, select the language of your choice.

Text entry

The following illustration shows how to enter the word *Nokia* with predictive text. With the English dictionary selected, press the following number keys one time only (6, 6, 5, 4, 2). The screen displays *Nokia* by predicting the letter and word, based on your keypad entry:

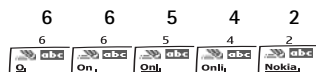

- Press 0 to enter a space, and begin writing the next word.
- If a displayed word is not correct, press * to see other matches. To return to the previous word in the list of matches, select *Previous*.
- If ? appears after a word, select *Spell* to add the word to the dictionary.
- Press 1 to insert a period into your message.
- Press and hold * to display special characters. Press * again to cycle through all available characters.

Change case and mode

Press # to switch between uppercase, lowercase, and sentence case text. As you press #, the following icons (not the descriptions) appear in the upper left of the display screen:

Uppercase text: standard mode is on.

Lowercase text: standard mode is on.

Sentence case text: standard mode is on.

This option is available only at the beginning of a sentence.

Note: You can press # within 2 seconds to switch between standard mode and predictive text mode.

Uppercase text: predictive text is on.

Lowercase text: predictive text is on.

Sentence case text: predictive text is on.

This option is available only at the beginning of a sentence.

4. Messages



If you have subscribed to a message network service, you can send and receive messages to compatible phones that are also subscribed to a message service. You can make distribution lists that contain phone numbers and names from your contacts list. See “[Create distribution lists](#)”, p. 15.

Your device supports the sending of text messages beyond the character limit of a single message. Longer messages are sent as a series of two or more messages. Your service provider may charge accordingly. Characters that use accents or other marks, and characters from some language options like Chinese, take up more space limiting the number of characters that can be sent in a single message.

When composing text messages, check the number of characters allowed in the top right corner of the message. Using Unicode characters takes up more space. With Unicode characters in your message, the indicator may not show the message length correctly. Before sending the message, the phone tells you if the message exceeds the maximum length allowed for one message.



Important: Exercise caution opening messages. Messages may contain malicious software or otherwise be harmful to your device or PC.



Note: When you send a message, your device may display *Message sent*, indicating your device has sent the message to the message center number programmed into your device. This is not an indication that the message has been received at the intended destination. For more details about messaging services, check with your network operator.

■ Create distribution lists

Distribution lists allow you to send text messages to a designated group of people.

1. Select *Menu > Messaging > Text messages > Distribution lists > New list*.

If you create a second distribution list, select *Menu > Messaging > Text messages > Distribution lists > Create new list*.

2. Enter a name for the list, and select **OK**.

A distribution list only contains phone numbers of recipients.

Add and remove contacts

To add contacts, select **Menu > Messaging > Text messages > Distribution lists > the list > Add new**. Add the contacts one by one.

To remove all contacts from the list, select **Menu > Messaging > Text messages > Distribution lists > the list > Options > Clear list**.

Manage distribution lists

1. Select **Menu > Messaging > Text messages > Distribution lists**.
2. Lists you have created appear in the display. Scroll to the list you wish to modify; select **Options** and one of the following:
 - Create new list**—Create a new distribution list.
 - Rename list**—Rename the distribution list.
 - Clear list**—Clear the distribution list of all current contacts.
 - Delete list**—Delete the distribution list.

Text messages

Write and send

1. Select **Menu > Messaging > Text messages > Create message**.
2. Write a message using the keypad.

Depending on the messaging service enabled, some or all of the following options are available while writing your message:

 - Sending options > Mark or Unmark > Urgent, Delivery reports, Callback number;** or **Signature**.

Select **Sending options** for a single message. See "**Sending options**", p. 20.

Clear all—Erase all the text from the message editor.

Add-ins—Add sounds, animations, or pictures to a text message.

Styles—Select font size, font appearance, and text alignment of a text message.

Insert contact—Insert a name from your contacts list into your message.

Insert number—Insert a phone number or find a phone number in the contacts list.

Save—Select **Drafts** to save the message in the drafts folder or **Templates** to save the message as one of your predefined templates in the templates folder.

Exit editor—Exit the message editor.

Use template—Insert a predefined template into your message.

Insert smiley—Insert a smiley into your message.

Insert word or *Edit word*—Enter or edit the text of a new word that might not appear in the predictive text dictionary (only available with predictive text on).

Insert symbol—Insert a special character into your message (only available with predictive text on).

Writing language—Choose the language you want to use.

Prediction on or *Prediction off*—Turn the predictive text on or off.

Matches—View matches in the dictionary for the word you want to use (only available with predictive text on and when the same set of key presses can produce multiple words).

- To send the message, select *Send to* > *Recently used*, *Send to number*, *Send to distrib. list* (if a distribution list has been created), or *Send to many*.
- Enter the recipient's phone number or e-mail address, or select *Search* to retrieve a number or e-mail address from your contacts list; select *OK*.

Read message

When you receive a message, a notification message and  are displayed.

- Select *Show* to read the message or *Exit* to dismiss the notification and read the message later from your inbox. See "[View saved messages](#)", p. 18.
- Scroll up or down to view the whole message, if necessary.

Options

When reading a text message, select *Options* to access some or all of the following options:

Delete—Discard the message.

Use detail—Use or save the number, e-mail address, or Web address.

Move—Save the message to *Archive*, *Templates*, or a folder you have created.

Forward—Forward the message to another phone number or e-mail address.

Lock or *Unlock*—Lock or unlock the message.

Rename—Edit the title of the message.

Reply to message

- Select *Menu* > *Messaging* > *Text messages* > *Inbox* and your desired message, or when you receive a message, select *Show*.

2. Select *Reply > Empty screen, Original text, Template*, or one of the predefined answers; then compose your reply using the keypad.
3. After creating the reply, select *Send*. The sender's phone number or e-mail is used as the default.

Templates

Templates are short, prewritten messages you can recall and insert into new text messages when you are short on time.

1. Select *Menu > Messaging > Text messages > Create message > Options > Use template*.
2. Select your desired template.
3. Select *Send to > Recently used, Send to number, Send to e-mail, Send to many*, or *Send to distrib. list* (if a distribution list is created).
4. Enter the recipient's phone number or e-mail address, or select *Search* to retrieve a number or e-mail address from your contacts list; select *Send*.

Text message folders

Save messages

You can save drafts of messages or received messages to an existing folder or to a folder that you have created.

1. Open the received message or create a new message, and select *Options*.
2. To save a received message, select *Move > Archive, Templates*, or a folder you have created.
To save the draft of a message you have created, select *Save > Drafts* or *Templates*.

View saved messages

1. Select *Menu > Messaging > Text messages*.
2. Select the folder containing the message you want to view:
Inbox—Automatically stores any incoming messages
Outbox—Stores messages that have not been sent
Sent items—Stores messages that have been sent
Drafts—Stores messages created as drafts
Archive—Stores messages that you choose to archive, including unread ones

Templates—Stores pictures and prewritten templates. Preloaded templates can be edited and personalised.

My folders—Allows you to organise your messages by creating custom folders and saving some of your messages here. Select **Options > Add folder, Rename folder,** or **Delete folder** to add a custom folder or rename or delete a folder you have created.

You can only delete folders created in my folders; the inbox, sent items, archive, and templates folders are protected. When deleting a folder, you are also deleting all messages in the folder.

Distribution lists—Stores created distribution lists

- When the folder opens, select the message you want to view.

Delete messages

If your message memory is full and you have more messages waiting at the network, **No space for new messages** appears in standby mode. You can do the following:

- Read some of the unread messages, and delete them individually.
- Delete messages from some of your folders.

Delete a single message

- Select **Menu > Messaging > Text messages**.
- Select the folder containing the message you want to delete.
- Highlight the message you want to delete.
- Select **Options > Delete**.
- Select **Yes** to delete the message or **No** to exit.

Delete all messages in a folder

- Select **Menu > Messaging > Text messages > Delete messages**.

- Select the messages you want to delete:

All—Deletes all messages in all of the folders

All read—Deletes any messages that have been read in all of the folders

All unread—Deletes any messages that have not been read in all of the folders

- Select and mark the folders that have messages you want to delete:

Inbox—Deletes all messages from the inbox folder

Sent items—Deletes all messages from the sent items folder

Outbox—Deletes all messages from the outbox folder

Drafts—Deletes all messages from the drafts folder

Archive—Deletes all messages from the archive folder

User defined folders—Deletes all messages from the user defined folder

4. Select **Done** > **Yes** to empty the marked folder.

Sending options

To change sending options for all text messages, select **Menu** > **Messaging** > **Text messages** > **Message settings** > **Sending options** and the setting you want to change:

Priority > **Normal** or **Urgent**—Set the priority of a message.

Delivery reports > **On** or **Off**—Send a note to yourself confirming delivery of the message.

Send callback no.—Send a callback number to the recipient. Select **Off** or enter your desired phone number to send to the recipient as a callback number, and select **OK**.

Signature—Select **On** to create a signature to send with text messages or **Off** to turn this feature off.

To change sending options for one message, select **Menu** > **Messaging** > **Text messages** > **Create message** > **Options** > **Sending options**, mark or unmark the setting you want to change:

Urgent—Set the priority of the message as urgent.

Delivery reports—Send a note to yourself confirming delivery of the message.

Callback number—Enter your desired phone number to send to the recipient as a callback number, and select **OK**.

Signature—Create a signature to send with the text message.

Other settings

Select **Menu** > **Messaging** > **Text messages** > **Message settings** > **Other settings** and the setting you want to change:

Save rcvd. text msgs.—Select **UIM/ph. if no mem.**, **Phone only**, or **UIM card only**.

Message font size > **Small font**, **Normal font**, or **Large font**

Message overwriting > **Sent items only**, **Inbox only**, **Sent items & Inbox**, or **Off**



Note: When the message memory is full, your phone cannot send or receive any new messages. To free up the memory, you can select **Message overwriting** to make your phone automatically replace old messages in the inbox and outbox folders when new ones arrive.

Save sent messages > Always save, Always prompt, or Off

Queue if no digital > On, On prompt, or Off—Messages are stored in the outbox until they can be sent with digital service.

■ Voice messages

If you subscribe to voice mail, your network operator will give you a voice mailbox number. You need to save this number to your device to use voice mail. When you receive a voice message, your device beeps, displays a message, or both. If you receive more than one voice message, your device shows the number of voice messages received.

Save voice mailbox number

Your network operator may have already saved your voice mailbox number to your device. Select *OK* to leave the number unchanged.

1. Select *Menu > Messaging > Voice messages > Voice mailbox no.*. The voice mailbox number is displayed.
2. If the box is empty, enter the voice mailbox area code and number, and select *OK*.

Set up voice mail

1. After you save the voice mailbox number, in standby mode, press and hold 1.
2. When you connect to voice mail, and the prerecorded greeting begins, follow the automated instructions to setup voice mail.

Listen to voice messages

After you set up voice mail, in standby mode, press and hold 1; or select *Menu > Messaging > Voice messages > Listen to voice msgs.* to dial the voice mailbox number. When you connect and the prerecorded greeting begins, follow the automated instructions to listen to your voice messages.

Automate voice mail

Voice mail services vary by network operator. The following instructions are examples of common operations. Please check with your network operator for specific instructions on using your voice mail service.

Write down voice mailbox number and process

1. Write down your voice mailbox number.
2. Call and check your voice mail as you normally would.
3. Write down your interaction with the recorded prompts step-by-step.

Keep in mind that each voice mail service may vary. However, it should look similar to the following:

Dial 8585551212, pause 5 seconds, press 1, pause 2 seconds, press 1234, and press #.

Phone numbers with dialling codes

You can insert special characters called dialling codes into phone numbers such as voice mail, and save the number to a speed dialling location.

Dialling codes instruct the receiving system to pause, wait, bypass, or accept the numbers that follow them in the dialling string. To set up dialling codes, do the following:

1. Select *Menu > Contacts > Speed dials*.
2. Scroll to an (*empty*) speed dialling slot, and select *Assign*.
3. Enter your mailbox phone number, including the area code.
4. Enter any dialling codes as necessary after the entered phone number.

For example, if you pause for 5 seconds after connecting to voice mail, enter p twice (two times 2.5 seconds) after the voice mailbox number: 2145551212pp.

5. Enter any remaining pauses or other information that enables you to listen to your messages, and select *OK*.
6. Enter a name (such as voice mail), and select *OK*.

To dial and listen to your voice mail, press and hold the assigned speed dialling key in standby mode.

Insert dialling codes

Press * repeatedly to cycle through dialling codes. When the desired code appears in the display, pause briefly, and the code is inserted into the dialling string.

The following dialling codes are available:

- *—Bypasses a set of instructions
- p—Pauses for 2.5 seconds before sending any numbers that follow
- +—Replaced by the international access code
- w—Waits for you to press the call key before sending the numbers or codes that follow

Clear voice mail icon

To clear the voice mail icon from the display, select *Menu > Messaging > Voice messages > Clear voice msg. icon*.

■ Web messaging

Web messaging is a network service.
See "[Network services](#)", p. [viii](#).

If your network operator supports this feature, you can use the minibrowser to check for e-mail messages.

Select *Menu > Messaging > Browser msgs. > Connect*.



Important: Exercise caution when opening messages. E-mail messages may contain malicious software or otherwise be harmful to your device or PC.

5. Log



Log stores information about the last 30 missed, received, or dialled calls. It also displays the total duration of all calls. When the number of calls exceed the maximum, the most recent call replaces the oldest.

When viewing missed, received, or dialled calls, the menu options are the same:

Time of call—Display the date and time of the call.

Send message—Send a message to the number.

Use number—Edit the number and associate a name with the number.

Save—Enter a name for the number and save it to your contacts list.

Add to contact—Add the number to an existing name in your contacts list, if the number is not associated with a name.

Delete—Clear the number from memory.

Call—Call the number.

■ View missed calls

Missed calls are calls that were never answered. The missed calls feature does not function when your phone is switched off.

1. Select *Menu > Log > Missed calls*; select *List*.
2. Scroll to a name or number, select *Options*, and an option.

■ View received calls

Received calls are calls that have been answered.

1. Select *Menu > Log > Received calls*.
2. Scroll to a name or number, select *Options*, and an option.

■ View dialled numbers

Dialled calls are numbers you have previously dialled from your phone:

1. Press the call key; or select *Menu > Log > Dialled numbers*.
2. Scroll to a name or number, and select *Options* and an option.

■ View message recipients

You can view recipients of messages you have sent. Select *Menu > Log > Msg. recipients.*

■ Clear log lists

You can delete any missed, dialled, or received calls from phone memory. Select *Menu > Log > Clear log lists > All call lists, Missed calls, Received calls, Dialled numbers, or Msg. recipients.*

■ Call duration



Note: The actual invoice for calls and services from your service provider may vary, depending on network features, rounding off for billing, taxes, and so forth.

To view the duration of your calls, select *Menu > Log > Call duration* and one of the following options:

Last call—Check the time of your last call.

Dialled calls—Check the combined time of calls you dialled for either *Home* or *Roaming*.

Received calls—Check the combined time of calls you received for either *Home* or *Roaming*.

All calls—Check the combined time of all calls.

Life timer—Check the total airtime minutes logged on your phone.

Clear timers—Enter your lock code, and select *OK* to clear all timers on your phone.



Note: Some timers, including the life timer, may be reset during service or software upgrades.

■ Data or fax calls

Data/fax calls are a network service. See "Network services", p. viii, for more information. If your wireless service provider or network operator supports this feature, you can view the size or duration of sent or received data and fax calls.



Note: The actual invoice for calls and services from your service provider may vary, depending on network features, rounding off for billing, taxes and so forth.

Select *Menu > Log > Data/fax calls* and one of the following options:

Last sent data/fax—View the size (KB) of the last sent data or fax call.

Last rcvd. data/fax—View the size (KB) of the last received data or fax call.

All sent data/fax—View the size (KB) of all sent data and fax calls.

All received data/fax—View the size (KB) of all received data and fax calls.

Duration of last call—View the duration time of the last data or fax call.

Duration of all calls—View the duration time of all calls.

Clear all data/fax registers—Select **Yes** to clear all data and fax registers.

Rcvd. browser data—View the size (KB) of all received browser data.

Last browser session—View the duration time of the last browser session.

All browser sessions—View the duration time of all browser sessions.

Clear all browser logs—Select **OK > Yes** to clear all browser logs.

■ Duration of minibrowser calls

Minibrowser is a network service. See “[Network services](#)”, p. [viii](#), for more information. If your wireless service provider or network operator supports this feature, you can view the size or duration of sent or received data from the minibrowser.



Note: The actual invoice for calls and services from your service provider may vary, depending on network features, rounding off for billing, taxes and so forth.

Select **Menu > Log > Browser calls** and one of the following options:

Last sent data—View the size (KB) of the last sent browser data.

Last received data—View the size (KB) of the last received data.

Sent browser data—View the size (KB) of all sent browser data.

6. Contacts



The contacts list can hold up to 500 contacts with multiple numbers and text notes for each contact. The amount of numbers and text entries you can save may vary, depending on the length and total number of entries in the contacts list.

■ Add new contacts

To access the contacts list in standby mode, select *Menu > Contacts > Names*.

Save contact name and number

1. In standby mode, enter the phone number you want to save.
2. Select *Save*.
3. Enter the name, and select *OK*.

Save contact number only

1. In standby mode, enter the phone number you want to save.
2. Select and hold *Options*.

Save an entry

1. In standby mode, select *Menu > Contacts > Names > Options > Add new*.

2. Enter the name, and select *OK*.
3. Enter the phone number, and select *OK > Back*.

Save numbers and text items

You can save different types of phone numbers and short text items per name to the contacts list. The first number you save for any entry is automatically set as the default, or default number, which you can always change.

1. In standby mode, scroll down to display your contacts list, and highlight the entry to which you want to add a phone number or text item.
2. Select *Details > Options > Add detail > Number (General, Mobile, Home, Office, or Fax), Tone, E-mail address, Web address, Postal address, Note, or Image*.
3. Enter the number or text for the type you have selected, and select *OK*.
4. To change a number type, highlight the number, and select *Options > Change type > General, Mobile, Home, Office, or Fax*.

Change default number

You can also change which phone number is the default (primary) number for the contact entry.

1. In standby mode, scroll down to select the contact entry you want to change, and select *Details*.
2. Scroll to the number you want to set as default, and select *Options > Set as default*.

Caller groups

You can add contacts list entries to any of five caller groups, and assign a unique ringing tone or graphic to that group. This enables you to identify callers from the group by their unique ringing tone or graphic.

1. To assign an entry in your contacts list to a caller group, select your desired contact entry, and select *Options > Details*.
2. To manage your caller groups, in standby mode, select *Menu > Contacts > Caller groups > Group details* to display the following caller group options:
 - Group name*—Rename the group to your preference.
 - Group ringing tone*—Set the ringing tone for the group.
 - Group logo > On or Change*—Set the graphic for the caller group.
 - Group members*—Add or remove members from the caller group.

Set up Speed dials

You can associate any entry in the contacts list with a key from 2-9. To dial those entries, press and hold the assigned key. See "*Set up Speed dials*", p. 28 to activate or deactivate Speed dials.

Assign a key to Speed dials

1. In standby mode, select *Menu > Contacts > Speed dials*.
2. Scroll to an (*empty*) slot, and select *Assign*.
3. Enter the number (including the area code) and a name for the number, and select *OK*; or select *Search* to retrieve a number from the contacts list.

If Speed dials is off, the device displays a prompt and asks if you want to turn speed dialling on.
4. Select *Yes* to activate Speed dials.

Change speed dialling numbers

1. In standby mode, select *Menu > Contacts > Speed dials*.
2. Scroll to the Speed dials entry you want to change, and select *Options > Change*.
3. Enter the new number and a name for the entry, and select *OK*; or select *Search* to retrieve a number from the contacts list.

Delete speed dialling numbers

1. In standby mode, select *Menu > Contacts > Speed dials*.
2. Scroll to the entry you want to delete, and select *Options > Delete > Yes*.

Voice tags

You can dial up to 25 stored numbers using voice dialling.

Before using voice tags, note the following:

- Voice tags are not language-dependent. They depend on the speaker's voice.
- You must say the name exactly as you said it when you recorded it.
- Voice tags are sensitive to background noise. Record voice tags, and use them in a quiet environment.
- Very short names are not accepted. Use long names and avoid similar names for different numbers.



Note: Using voice tags may be difficult in a noisy environment or during an emergency, so you should not rely on voice dialling in all circumstances.

Assign a voice tag to an entry

Before you can use voice dialling, you must first assign a voice tag to the number.

1. In standby mode, scroll to the entry in your contacts list to which you want to assign a voice tag.
2. Select *Details > Options > Add voice tag > Start*.
3. Speak clearly into the microphone. Do not select *Quit* unless you want to cancel the recording. The device automatically stops recording, and saves and replays the voice tag.

appears next to commands that have voice tags assigned.

Dial a number

1. In standby mode, press and hold the right selection key with the fold open, or press and hold the voice key regardless of the fold being open or closed.
2. When you hear several beeps and *Speak now* appears, release the key.
3. Pronounce the voice tag clearly into the microphone.

When the device finds the voice tag, *Found:* appears, and the device automatically dials the number. If the device does not locate a number or recognise the voice tag, *No match found* appears.

Voice tags

1. After you have associated a voice tag to a contact, select *Menu > Contacts > Voice tags* and your desired voice tag entry.
2. Select *Playback, Change, or Delete*.

■ Edit contacts list entries

1. In standby mode, select *Menu > Contacts > Names*, and scroll to the entry you want to edit in your contacts list.
2. Select *Details > Options* and one of the following options, which may vary depending on whether you are editing a contact listed by phone number or contact name:

View—View the phone number of the contact.

Add detail—Add more details to the contact: *Name* (only available with no name added), *Number (General, Mobile, Home, Office, or Fax)*, *E-mail address, Web address, Postal address, Note, Image* (only available with no image added), or *Tone*.

Edit name, Edit number, Edit detail, or Change image—Edit an existing contact name, phone number, details, or image attached to the contact.

Delete—Delete more details (*Delete number, Delete detail, or Delete*

detail) or the entire contact entry (*Delete contact*) of the contact.

Send message—Create and send the contact a text message.

Use number—Use or save the number (available when you select a contact listed with a contact name). Select *Options* to use the number.

Set as default—Change the default number of the contact.

Change type > General, Mobile, Home, Office, or Fax—Change the number type.

Add voice tag or Voice tag—Add a voice tag to the contact with no voice tag assigned, or select *Playback, Change, or Delete* with a voice tag assigned.

Copy number—Copy the number from the phone memory to the UIM card or from the UIM card to the phone memory.

Send business card—Send the contact as a business card to another device.

Caller groups—Select *No group* to remove a contact from a caller group or *Family, VIP, Friends, Business, or Other* to add a contact to an existing caller group.

Speed dials—Add the contact to your speed dialing list.

3. Edit the option to your preference, and select *OK*.

■ Delete contacts entries

To delete all entries in your contacts list, in standby mode, select *Menu > Contacts > Del. all contacts*.

■ Access the contacts menu

- In standby mode, select *Menu > Contacts* and one of the following options:
 - Names*—View the entries in your contacts list, and select *Details* or *Options > Search, Add new, Delete contact*, or *Copy* for your selected entry.
 - Settings*—Change the contacts list view or check the memory status of your device. To set the default memory, select *Phone and UIM, Phone*, or *UIM card*.
 - Caller groups*—View and edit the properties of any of the caller groups on the device.
 - Voice tags*—Listen to, modify, or delete a voice tag to a contact in the contacts list.
 - Speed dials*—View or modify the list of speed dialling numbers.
 - Del. all contacts*—Delete all entries in your contacts list.
- Select an option to activate the feature or access its submenu.

Search for a name

- In standby mode, scroll down to display the contents of your contacts list.
- Press the key corresponding to the first letter of the name for which you are searching.
- Scroll to select a contact, and select *Details* to view the details.

Configure settings

You can select how the contacts appear in your contacts list and view the amount of memory used or available in your device. In standby mode, select *Menu > Contacts > Settings > Scrolling view* to change view of name list or *Memory status* to view the device memory used and remaining.

■ Send and receive contacts

You can send and receive an entry in your contacts list using text messaging, if supported by your network operator.

Send a business card

You can send a business card as a text message to a compatible phone or other handheld device.

1. Highlight your desired entry from your contacts list, and select *Details > Options > Send business card > Via text message, Via infrared, or Via Bluetooth*. *Default number* and *All details* options appear only if you have more than one number or detail saved to the contact entry.
2. Enter the number for your recipient, or select *Search* to retrieve a number from your contacts list.
3. Select *OK* and the business card is sent.

7. Gallery



You can save pictures, video clips, recordings, and ringing tones to folders in the *Gallery* and add new folders.

You can download images and tones using SMS, mobile Internet sites, or Nokia PC Suite.

Your device supports a digital rights management system to protect content you have acquired.

Content such as ringing tones, can be protected and associated with certain usage rules, for example, the number of usage times or a certain usage period. Usage rules are defined in the content activation key that can be delivered with the content or delivered separately, depending on your network operator. You may be able to update the activation key. Always check the delivery terms of any content and activation key before acquiring them, as they may be subject to a fee.

Copyright protection may prevent some images, ringing tones, and other content from being copied, modified, transferred, or forwarded.

Your device has about 21 MB of memory for storing files in the *Gallery*. This memory is not shared with other functions, such as contacts. If the device displays a message that the

memory is full, delete some existing files before proceeding.

■ Folders

1. Select *Menu > Gallery > Memory card > Images, Video clips, Themes, Graphics, Tones, Recordings, Received files*, or a folder you created.
2. Select *Open* to view a list of the files in the folder or *Options* to access the following:
 - Memory card*—When a microSD card is in the phone, the card name is displayed as the first option. To rename the microSD card, select *Open > Options > Rename mem. card*.
 - Delete folder*—Delete a folder you have created. You cannot delete a preset folder.
 - Move*—Move the selected folder into another folder. After selecting *Move*, scroll to another folder, and select *Move to*. You cannot move a preset folder.
 - Rename folder*—Rename a folder you have created. You cannot rename a preset folder.
 - Details*—Show the name, size, and date of creation of the selected folder.

Type of view > *List with details*, *List*, or *Grid*—Determine how to display the folders and files within them.

Sort—Sort the contents of the selected folder by name, date, format, or size.

Add folder—Create a new folder.

Memory status—Check the available memory for the device handset.

Activation key list—View the list of available activation keys. You can delete activation keys if desired.

Mark or *Unmark*—Mark or unmark folders to be deleted or moved.

Mark all—Mark all folders to be deleted.

When adding text, you can select the font style, size, and colour, and rotate the font.

■ Fun frames and clip art

In the gallery, you can select photos and clip art and save them as screen savers and wallpaper. To personalise photos, clip art, screen savers, and wallpaper add your own text, add a frame, change the size of an image, and adjust the contrast.

Select *Menu* > *Gallery* > *Memory card* > *Images* > *Options* > *Edit image* > *Options* > *Insert text*, *Insert frame*, *Insert clip-art*, *Insert image*, or *Crop image*.

8. Media



■ Camera

You can take photos and record video clips with the built-in 2.0 megapixel camera. The camera lens is on the back of the phone. The camera produces pictures in JPEG format and video clips in 3GP format.

When taking and using images or video clips, obey all laws and respect local customs as well as privacy and legitimate rights of others.

Your device supports image capture resolutions of up to 1600 x 1200 pixels. The image resolution in these materials may appear different.

If there is not enough memory to take a new photo, delete old photos or other files in the gallery, or move photos to a microSD card. See "MicroSD card," p. 18.

Keep a safe distance when using the flash. Do not use the flash on people or animals at close range. Do not cover the flash while taking a picture.

Take a photo

Select *Menu > Media > Camera*. To take a photo, select *Capture*. Photos are saved in the *Images* folder of the gallery. To take another photo,

select *Back*; to send the photo, select *Send*. To view the options, select *Options*.

Record a video clip

Select *Menu > Media > Camera > Options > Video*. Select *Record* to begin recording the video clip. Select *Pause* to pause, *Continue* to resume, or *Stop* to stop the recording. Video clips are saved in the *Video clips* folder of the gallery menu.

Camera options

Select *Menu > Media > Camera > Options* and from the following: *Still image* or *Video*—Choose *Still image* to take a picture or *Video* to record a video.

Mute audio or *Unmute audio*—Turn the sound on or off for the video clip.

Night mode on or *Night mode off*—Switch the camera night mode on and off.

Flash on or *Flash off*—Turn the camera flash on and off.

Self-timer on or *Self-timer off*—Turn the self-timer on and off with still images.

Img. sequence on or *Img. sequence off*—Turn image sequencing on or off. The pictures are then saved to the gallery. This option only appears in still image mode.

View previous—View the previous photo or video taken. This option only appears when a photo has been taken during that session.

Open Gallery—Open the *Gallery* to view saved images, videos, and recordings.

Settings—Change the settings for the phone camera.

■ Media player

With the media player you can download, view, and play compatible images, audio and video files, and animated images from a variety of sources.

The media player enables you to play streaming videos and streaming audio from a network server. Streaming functionality is a network service and requires network support. Check the availability of these services, pricing, and tariffs with your network operator or the service provider whose service you want to use. Network operators will also give you instructions on how to use their services.

In standby mode, select *Menu* > *Media* > *Media player* > *Online media* > *Open Gallery*, *Go to address*, or *FF/Rew interval*.

Online media—Connect to the operator's network. This is a network service. Check with your network operator for pricing and information.

Open Gallery—Open the *Gallery*. From *Gallery*, you can play stored audio and video files.

Go to address—Connect to a web address.

FF/Rew interval—Set the fast forward and rewind interval to 10 seconds, 20 seconds, 30 seconds, or set an interval.

■ Music player

Your phone includes a music player for listening to music or other tracks in MP3 or AAC format. To listen to the music files, you must connect a compatible headset.



Warning: When using the stereo headset your ability to hear outside sounds may be affected. Do not use the stereo headset where it can endanger your safety.

Music files stored in the *Menu* > *Gallery* > *Music files* folder are automatically detected and organised into categories.

Your phone can receive incoming calls during music player. If a song is playing, the music stops. To restart the music after the call is complete, select .

To transfer music tracks from a compatible PC to your phone and to manage music tracks and track lists, see the instructions for the Nokia Audio Manager application in the Nokia PC Suite online help.

See "[Infrared connectivity](#)", p. 52, or "[Bluetooth connectivity](#)", p. 49.

Play music tracks



Warning: Listen to music at a moderate level. Continuous exposure to high volume may damage your hearing.



To open the music player, select *Menu > Media > Music player*. If there are no music files in the *Music files* folder, you can select another folder before entering the *Music player*. The details of the first track on the default track list are shown.

Select track—To select a track, press the upper side of the scroll key and select a track from the list.

Play track—To play a track, select .

Adjust volume—To adjust the volume level, use the volume key.

Pause—To pause the playing, select .

Skip tracks—To skip to the beginning of the next track, select . To skip to the beginning of the previous track, within the first second of the song, select  twice.

Rewind or fast forward—To rewind the current track, press and hold the left side of scroll key. To fast forward the current track, press and hold the right side of scroll key. Release the key at the position you want.

Music player options

To open the music player options, select *Menu > Play > Music player > Options* and a choice.

Radio



Warning: Listen to music at a moderate level. Continuous exposure to high volume may damage your hearing. Do not hold the device near your ear when the loudspeaker is in use, because the volume may be extremely loud.

Your phone has an FM radio that also functions as an alarm clock radio. To listen to the FM radio on your phone, connect a compatible music stand, a 2.5 mm headset, or stereo headset. The FM radio uses the wire of the headset as an antenna. A compatible headset needs to be attached to the device for the FM radio

to function properly. The quality of a radio broadcast depends on coverage of the radio station in that particular area.

Select *Menu > Media > Radio*. To use the graphical keys, ▲, ▼, ◀, ▶, or ⏪ on the display, scroll left or right to the desired key, and select it. To change the volume, press the volume keys.

■ Save radio channels

1. To start the channel search, select and hold ◀ or ▶. To change the radio frequency in 0.1 MHz steps, briefly press ◀ or ▶.
2. To save the channel to a memory location 1 to 9, press and hold the corresponding number key. To save a channel to a memory location 10 to 20, briefly press 1 or 2, then press and hold the desired number.
3. Enter the name of the channel, select *OK*.

When an application using a browser connection is sending or receiving data, it may interfere with the radio.

When you place or receive a call, the radio automatically mutes. Once the call is ended, the radio switches back on.

■ Listen to the radio

Select *Menu > Media > Radio*.

To scroll to the desired channel, select ▲ or ▼, or press the headset key. To select a radio channel location, briefly press the corresponding number keys.

Select *Options* and from the following options:

Switch off—Turn off the radio.

Save station—Enter a name for the channel, and select *OK*. Select one of 20 locations to save the channel location.

Stations—Select from list of current saved channels on your phone. Select *Options > Delete station* to clear channels or *Options > Rename* to rename channels.

Mono output or *Stereo output*—Listen to the radio in monaural mode or in stereo (default). Stereo output is available through a stereo enhancement.

Headset or *Loudspeaker*—With the headset attached, listen to the radio through a headset or the loudspeaker.

Set frequency—Manually enter the frequency of a known radio station, and select *OK*. You can also press * to set a frequency.

You can normally make a call or answer an incoming call while

listening to the radio. During the call, the volume of the radio is muted.

■ Voice recorder

You can record pieces of speech, sound, or an active call for up to 3 minutes. The recorder cannot be used when a data call is active.

Record speech or sound

1. Select *Menu > Media > Voice recorder*.
2. To start the recording, select the record virtual button. To start the recording during a call, select *Options > Record*. While recording a call, all parties to the call hear a faint beeping sound about every 2 seconds. When recording a call hold the phone in the normal position near your ear.
3. To end the recording, select the stop virtual button. The recording is saved in *Gallery > Recordings*.
4. To listen to the latest recording, select *Options > Play last recorded*.
5. To send the last recording using a Bluetooth technology, or IR, select *Options > Send last recorded*.

■ Equaliser

The equaliser enhances the sound quality when using *Music player* by amplifying or attenuating frequency

bands. There are five preset equaliser settings (*Normal, Pop, Rock, Jazz, and Classical*) and two personal settings.

Activate an equaliser set

Select *Menu > Media > Equaliser*, scroll to the desired equaliser setting, and select *Activate*. Select *Options > View* to display the equaliser settings.

Create a custom equaliser set

1. Select *Menu > Media > Equaliser*.
2. Highlight a customisable setting, and select *Options > Edit*.

The selected set appears in the display with the bar on the far left highlighted. The bars adjust frequencies, from the lowest (the far left bar) to the highest (the far right bar). The higher the indicator on a particular bar, the more that frequency is amplified.

3. Scroll to adjust the frequencies. Select *Save*.
4. To rename the setting, select *Options > Rename*, enter a new name, and select *OK*.
5. To activate the setting, select *Activate*.

9. Settings



Use this menu to change profiles, display settings, themes, tone settings, time and date settings, call settings, phone settings, voice commands, connectivity settings, enhancement settings, security settings, application settings, network settings, network services, restore factory settings, and phone details.

■ Profiles

Profiles define how your device reacts when you receive a call or message and how your keypad sounds when you press a key. You can leave ringing options, keypad tones, and other settings for each of the available profiles at their default setting, or personalise them to suit your needs.

Profiles are also available for enhancements such as the headset and car kit. See "Enhancements", p. 54.

To activate a profile, select *Menu > Settings > Profiles > General, Silent, Meeting, Outdoor, (My profile 1), or (My profile 2) > Activate*.

Personalise a profile

You can personalise any of the profiles in various ways.

1. Select *Menu > Settings > Profiles*.
2. Select the profile you want to personalise.
3. Select *Personalise* and the option you want to personalise.

Set a timed profile

You can use timed profiles to prevent missed calls. For example, suppose you attend an event requiring your device set to *Silent* before the event starts, but you forget to return it to *General* until long after the event. A timed profile can prevent missed calls by returning your device to the default profile at a time you specify. You can set timed profiles up to 24 hours in advance.

1. Select *Menu > Settings > Profiles*.
2. Select the profile you want to activate and *Timed* for timed expiration.
3. Enter the time in hh:mm format for the profile to expire, and select *OK*.

■ Display

Standby mode settings

You can choose settings for the display of the standby screen on the display.

Wallpaper

Select *Menu > Settings > Display > Standby mode settings > Wallpaper* and one of the following:

On—Activate wallpaper on your phone.

Off—Deactivate wallpaper on your phone.

Image—Choose an image from the gallery for wallpaper. Select *Open* to browse the *Images* folder. Select the image of your choice.

Slide set—Choose a slide set from the gallery for wallpaper. Select *Open* to browse the *Images* folder. Select the slide set of your choice.

Font colour

To set the font colour of your phone when in standby mode, select *Menu > Settings > Display > Standby mode settings > Standby font colour*. Scroll to select a colour from the colour grid.

Screen saver

To choose a screen saver for the main display, select *Menu > Settings > Display > Screen saver* and one of the following:

On—Activate the screen saver on your phone.

Off—Deactivate the screen saver on your phone.

Screen savers > Image, Video Clip, Slide set, Digital clock, or Open Camera— an image, video clip, or other option to act as your screen saver.

Time-out—Modify the idle time before the screen saver activates.

Power saver is automatically activated after the time-out of the screen saver to optimise battery life.

Sleep mode

The sleep mode is a power-saving feature that turns the phone display off during inactivity. Select *Menu > Settings > Display > Sleep mode*.

When sleep mode is activated, the display is completely blank, but the phone is still active. Press any key to restore the display.

Backlight time-out

To control the time-out of the backlight on your phone, select *Menu > Settings > Display > Backlight time-out*.

■ Themes

A theme contains many elements for personalising your phone, such as wallpaper, screen saver, colour scheme, and a ringing tone.

Themes automatically loads wallpapers, screen savers, ringing tones and background colours. Selecting a theme over-writes previous settings. Individual settings for a theme can be overwritten independently in the settings menu. For example, a theme selects a wallpaper, a screen saver, and a default ringing tone. The default ringing tone within a theme can be overwritten. See "[Tone settings](#)", p. 42.

1. Your phone has a default theme. To choose the theme on your display, select *Menu > Settings > Themes > Select theme > Themes*.
2. Scroll to a theme, and select *Open > Apply*.

■ Tone settings

You can adjust the ringing volume, keypad tones, and more for the active profile. See "[Personalise a profile](#)", p. 40 for more information on profile settings.

Select *Menu > Settings > Tones* and one of the following:

Incoming call alert—Select how the device notifies you of an incoming call.

Ringing tone—Select the ringing tone for incoming calls.

Incoming call video > Incoming call video off or *Incoming call video on*—Indicate whether to replace the default audio ringing tone with the selected video.

Ringing volume—Set the volume of your ringing tone.

Vibrating alert > On or *Off*—Set the vibrating alert.

Message alert tone—Select the tone for received messages.

Keypad tones—Set the volume of your keypad tones (or turn them off).

Warning tones > On or *Off*—Set warning and confirmation tones.

Alert for—Define which caller groups the selected profile will accept or decline. See "[Caller groups](#)", p. 28.

■ Time and date settings

Clock

Select *Menu > Settings > Time and date > Clock > Show clock*, or *Hide clock*, *Set the time*, *Time zone* or *Time format*.

Date

Select *Menu > Settings > Time and date > Date > Show date* or *Hide date*, *Set the date*, *Date format*, or *Date separator*.

Date and time auto-update

Auto-update is a network service.

See "Network services", p. viii. If your network operator supports this feature, you can allow the digital network to set the clock, which is useful when you travel to another network or time zone.

Select *Menu > Settings > Time and date > Auto-update of time > On*, *Confirm first*, or *Off*.

If you use the *Auto-update of time* option while outside the digital network, you may be prompted to enter the time manually. Network time replaces the time and date when you reenter your digital network.

If your battery has been removed or has discharged outside the digital network, you may be prompted to enter the time manually (when the battery is replaced or recharged, and you are still outside of the digital network).

Call settings

Anykey answer

Anykey answer enables you to answer an incoming call. Briefly press any key except the right selection or end key.

In standby mode, select *Menu > Settings > Call > Anykey answer > On* or *Off*.

Automatic redial

Occasionally, your network may experience heavy traffic, resulting in a fast busy signal when you dial.

With automatic redial activated, your device redials the number (number of times is specified by the network), and notifies you when the network is available. In standby mode, select *Menu > Settings > Call > Automatic redial > On* or *Off*.

Speed dialling

To activate or deactivate Speed dialling, select *Menu > Settings > Call > Speed dialling > On* or *Off*.

Automatic service update

Your device is capable of receiving updates to wireless services sent to your device by your network operator.

In standby mode, select *Menu > Settings > Call > Auto-service update > On* or *Off*.

Calling cards

If you use a calling card for long distance calls, save the calling card number in your phone. The phone can store up to four calling cards. Contact your calling card company for more information.

Save information

1. In standby mode, select *Menu* > *Settings* > *Call* > *Calling card*.
2. Enter your security code, and select *OK*. See "Security", p. 54.
3. Scroll to the calling card of your choice, and select *Options* > *Edit* > *Select* > *Dialling Sequence*.
4. Select one of the following sequence types:
 - Access+phone+card*—Dial the access number for the calling card, the phone number, then enter the card number (plus PIN if required).
 - Access+card+phone*—Dial the access number for the calling card, card number (plus PIN if required), then enter the phone number.
 - Prefix+phone+card*—Dial the prefix (numbers that must precede the phone number) and phone number, then enter the card number (plus PIN if required).
5. Enter the required information (access number or prefix and card

number), and select *OK* to confirm your entries.

6. Select *Card name* > enter the card name > *OK*.

Select a calling card

You can select one of the calling cards for which you have saved information. The selected card information is used when you make a card call.

1. In standby mode, select *Menu* > *Settings* > *Call* > *Calling card*.
2. Enter your security code, and select *OK*. See "Security settings," p. 80.
3. Scroll to the calling card of your choice, and select it.

Make card calls

After you have selected a calling card, make a card call.

1. Enter the phone number, including any prefix (such as 0 or 1) that your calling card may require when you make a calling card call. See your calling card for instructions.
2. Press and hold the send key for a few seconds until *Card call* is displayed.
3. Follow the instructions on the screen.
4. When you hear the tone or system message, select *OK*.

International prefix

You can store an international dialling prefix into your device. In standby mode, select *Menu > Settings > Call > International prefix*. In standby mode, when you enter + (press * twice) at the beginning of a phone number, your device automatically inserts the international dialling prefix that you have stored after you press the call key. See “*Insert dialling codes*”, p. 22.

Data or fax calls

Data and fax calling is a network service. See “*Network services*”, p. viii. If your network operator supports this feature, you can set up the device to send or receive data and fax calls with a terminal, such as a PDA or PC, connected.

For better performance during data calls, place the device on a stationary surface. Do not move the device or hold it in your hand during a data call.

For more information on connectivity, refer to the PC/PDA Connectivity Guide which can be downloaded from the Nokia website at <http://www.nokia-asia.com>.

1. In standby mode, select *Menu > Settings > Call > Data/fax calls > Rcvd. data/fax call* and one of the following options:

Normal—The device receives incoming calls as usual.

Data calls only—The device receives only data calls.

Fax calls only—The device receives only fax calls.

2. When finished with receiving the fax or data call, repeat steps 1 and 2, and select *Normal*.

Data transfer

To view the transmission speed when sending or receiving data and fax calls. In standby mode, select *Menu > Settings > Call > Data/fax calls > Data rate display > Graphic* or *Off*.

Call summary

Your device can display the time spent on a call when you hang up. In standby mode, select *Menu > Settings > Call > Call summary > On* or *Off*.

Show call time

To see the call time on the display screen after each call, select *Menu > Settings > Call > Show call time displ. > On* or *Off*.

Ringtone for no caller ID

You can select a different ringing tone for calls received with no caller ID.

In standby mode, select *Menu > Settings > Call > Ringtone no caller ID > On* or *Off*.

■ Phone settings

Language settings

The phone language affects the time and date formats of the clock, and alarm clock. In standby mode, select *Menu* > *Settings* > *Phone* > *Phone language* and the language of your choice.

The writing language selects the language used for messaging, calendar, notes, and To-do lists. In standby mode, select *Menu* > *Settings* > *Phone* > *Writing language* and the language of your choice.

Automatic keypad

You can set the keypad of your device to lock automatically after a preset time delay.

1. In standby mode, select *Menu* > *Settings* > *Phone* > *Automatic keypad* > *On* or *Off*.
2. If you select *On*, *Set delay:* is displayed.
3. Enter the delay time (in mm:ss format), and select *OK*.

When keypad is on, it may be possible to dial the emergency number programmed into your device.

Navigation key

If supported by your wireless service provider or network operator, you can set the features that are activated when you press the scroll key.

1. In standby mode, select *Menu* > *Settings* > *Phone* > *Navigation key*.
2. Highlight the scroll up, scroll down, scroll right, or scroll left arrow; select *Change*.
3. Select a function to assign to the action.

Memory status

You can view the size of memory available on your device. In standby mode, select *Menu* > *Settings* > *Phone* > *Memory status*.

You can view the size of memory available for application installations. In standby mode, select *Menu* > *Extras* > *Memory*.

DTMF tones

DTMF tones, are the tones that sound when you press the keys on your device keypad. You can use DTMF tones for many automated dial-up services such as banking and airlines or for entering your voice mailbox number and password.

DTMF tones are sent during an active call. You can send them manually from your device keypad, or send them automatically by saving them in your device.

Set type

In standby mode, select *Menu > Settings > Phone > DTMF tones > Manual DTMF tones* and one of the following options:

Continuous—Used to set the tone sound for as long as you press and hold a key.

Fixed—Used to send tones of the duration you specify in the *DTMF tone length* option.

Off—Used to turn off tones. No tones are sent when you press a key.

Set length

You can specify DTMF-tone length for the *Fixed* option. In standby mode, select *Menu > Settings > Phone > DTMF tones > DTMF tone length > Short* (95 ms) or *Long* (350 ms).

Start-up tone

You can select to have a start-up tone when you first turn on your device.

In standby mode, select *Menu > Settings > Phone > Start-up tone > On* or *Off*.

Help text activation

Your device displays brief descriptions for most menu items. When you arrive at a feature or menu, pause for about 14 seconds, and wait for the help text to be displayed. If necessary, use the scroll key to page through the full help text.

The default setting for help text is *On*. However, you can turn help text on or off. In standby mode, select *Menu > Settings > Phone > Help text activation*.

Voice commands and voice tags

Before using voice tags, note the following:

- Voice tags are not language-dependent, but depend on the speaker's voice.
- You must say the name exactly as you said it when you recorded it.
- Voice tags are sensitive to background noise. Record voice tags, and use them in a quiet environment.
- Very short names are not accepted. Use long names, and avoid similar names for different numbers.



Note: Using voice tags may be difficult in a noisy environment or during an emergency, so you should not rely on voice dialling in all circumstances.

Hands-free operation

You can set as many as 16 voice commands to enable hands-free operation of certain features in your device.

Assign a voice tag to a command

Before using voice commands, you must first add a voice tag to the device function.

1. Select *Menu > Settings > Voice commands*.
2. Select the device function you want to tag: *Profiles, Messages, Infrared, Voice recorder, or Log*.
3. If necessary, select an option associated with that function.
4. Select *Start*, and speak the voice tag clearly into the microphone. Do not select *Quit* unless you want to cancel the recording.

The device replays and saves the recorded tag.  appears next to commands with assigned voice tags.

Activate a voice command

After you have associated a voice tag with a function in your device, to issue a command, speak the voice tag.

1. In standby mode, press and hold the right selection key or voice key.
2. With *Speak now* displayed, pronounce the voice tag clearly into the microphone.

With the voice tag found, the device displays *Found*; and plays the recognised voice tag through the earpiece. The function you requested is activated.

Options

After you have associated a voice tag to a command, you can select one of the following options:

- Play*—Press the center selection key to listen to the voice command tag.
- Change*—Select *Options > Change* to change the voice command.
- Delete*—Select *Options > Delete* to erase the voice command tag.

Connectivity

You can connect the phone to a compatible devices using infrared (IR) connection, or Bluetooth wireless technology. You can also connect the phone to a compatible PC using IR or a USB data cable; and use the phone as a

modem to enable connectivity from the PC.

For more information, see the Nokia PC Suite online help. Nokia PC Suite and all related software can be downloaded from www.nokia-asia.com/pcsuite.



Important: Only install and use applications and other software from sources that offer adequate security and protection against harmful software.

Bluetooth connectivity

Bluetooth technology connectivity enables cost-free wireless connections between electronic devices and can be used to send and receive images, texts, gallery files, voice recordings, videos, notes, business cards, and calendar notes. It can also be used to connect wirelessly to products that use Bluetooth wireless technology, such as computers. You can synchronise your phone and your PC using Bluetooth connectivity.

Since devices with Bluetooth connectivity communicate using radio waves, your phone and the other device do not need to be in direct line of sight.

The two devices only need to be within a maximum of 30 feet (10 meters) of each other. The connection can be

subject to interference from obstructions such as walls or other electronic devices.

The Bluetooth wireless technology application whether used actively or in the background, consumes the battery and reduces the operating time of the phone.

This device is compliant with Bluetooth Specification 2.0 and supports the following profiles:

- Object push profile (OPP)
- File transfer profile (FTP)
- Dial-up networking profile (DUN)
- Generic object exchange profile (GOEP)
- Headset profile (HSP)
- Hands-free profile v. 1.0 (HFP)
- Generic access profile (GAP)
- Service Discovery Protocol (SDP)
- Serial port profile (SPP)

To ensure interoperability between other devices supporting Bluetooth technology, use only enhancements approved by Nokia for this model.

Check with the manufacturers of other devices to determine their compatibility with this device.

There may be restrictions on using Bluetooth technology in some locations. Check with your local authorities or service provider. If you want more information on this

function, visit the Bluetooth Technology organisation website: www.bluetooth.org/.

Pairing

You can set up a permanent association (pairing) between your phone and another device with Bluetooth technology. Some devices may require pairing before data transfer can take place.

To pair with a device, you and the owner of the other device must agree on a pass code of 1–16 numeric characters. The first time you try to connect the devices, you must each enter the same pass code. Once the devices are paired, you will not need to use the pass code again, so there is no need to remember it.

Paired devices are placed in your paired device list. You can view the list even when Bluetooth connectivity is not active or when the devices in the list are not available for connection.

Select *Menu > Settings > Connectivity > Bluetooth > Paired devices > Options* and one of the following:

Assign short name—Give a nickname to the selected device (visible to you only).

Auto-conn. without confirmation—Select *No* if you want the phone to connect to the selected device automatically or *Yes* if you want the phone to ask for your permission first.

Delete pairing—Delete the pairing to the selected device.

Pair new device—Search for active devices with Bluetooth technology within range, scroll to the desired device, and select *Pair* to establish pairing with that device. Do not accept Bluetooth connectivity from sources you do not trust.

Bluetooth connectivity settings

To define how your phone is shown to other devices with Bluetooth connectivity. Select *Menu > Settings > Connectivity > Bluetooth > Bluetooth settings* and one of the following:

My phone's visibility—Select *Perm. visible*. to permanently show the phone to all other devices with Bluetooth connectivity, *Temp. visible*. to show the phone to all other devices for two minutes only, or *Hidden* to show the phone only to the paired devices. Operating the phone in hidden mode is a safer way to avoid malicious software.

My phone's name—Change your phone name that is seen by other users.

Set up a connection

1. Select *Menu > Settings > Connectivity > Bluetooth > On*.
The active Bluetooth technology connection is indicated by  at the top of the display.
2. Select *Search for audio enhancements* to search for compatible devices with Bluetooth connectivity. The list of found devices appears in the display.
3. Select the desired device.
If required, enter the Bluetooth connectivity pass code of the device to complete the pairing.
4. If required, enter the Bluetooth connectivity pass code of the device to pair with the device.

Your phone connects to the device.
You can start data transfer.

To view the device you are connected to, select *Menu > Settings > Connectivity > Bluetooth > Active device*.

To deactivate Bluetooth connectivity, select *Menu > Settings > Connectivity > Bluetooth > Off*.
Deactivation of the Bluetooth technology connection will not affect other functions of the phone.

Send data

Instead of using the *Connectivity* menu, you can use other phone menus to send various types of data to other devices with Bluetooth connectivity. For example, you can send a video from the *Video clip* folder of the *Gallery* menu. See the appropriate sections of the user guide for information about sending different types of data.

Receive a data transfer

When a Bluetooth technology connection is active in your phone, you can receive notes, business cards, videos, and other types of data transfers from another device with Bluetooth connectivity. When you receive a data transfer, an alarm sounds, and a message appears on the screen.

To view the transferred item immediately from standby mode, select *Show*. To view the item at a later time, select *Exit*.

Depending on the nature of the item, it is saved in the appropriate menu in your phone. For example, a business card is saved in *Contacts*, and a calendar note is saved in *Calendar*.

Infrared connectivity

You can set up the phone to receive data through its infrared (IR) port. To use an IR connection, the device with which you want to establish a connection must be IrDA compliant. You can send or receive data to or from a compatible phone or data device (for example, a computer) through the IR port of your phone.



Warning: Do not point the IR beam at anyone's eye or allow it to interfere with other IR devices. This device is a Class 1 laser product.



When sending or receiving data, ensure that the IR ports of the sending and receiving devices are pointing at each other and that there are no obstructions between the devices.

To activate IR in your phone, select *Menu > Settings > Connectivity > Infrared*.

To deactivate the IR connection, select *Menu > Settings > Connectivity > Infrared*. When the phone displays *Deactivate infrared?*, select *Yes*.

If data transfer is not started within 2 minutes after the activation of the IR port, the connection is cancelled and must be started again.

IR connection indicator

When  is shown continuously, the IR connection is activated and your phone is ready to send or receive data through its IR port. When  blinks, your phone is trying to connect to the other device or a connection has been lost.

Data cable transfer

You can transfer data from your phone to a compatible PC or from a compatible PC to your phone using a CA-53 USB data cable.



Important: Disconnect the USB data cable from the phone to make a call.

Enable default mode connection

Connect to your PC in *Nokia mode* to transfer phone data and files between your phone and PC using Nokia PC Suite.

1. Connect your PC and your phone with a CA-53 USB data cable. A notification appears on the display that asking which mode you want to select.
2. Select *Accept > Nokia mode*. A notification appears on the display stating a connection is active.

You can now use PC Suite to connect to your phone.

Enable data storage connection

Connect to your PC in *Data storage* mode to transfer music, photo, and video files to the phone microSD card, and from the phone microSD to your PC with Windows Explorer.

1. Connect your PC and your phone with a CA-53 USB data cable. A notification appears on the display that asking which mode you want to select.
2. Select *Accept > Data storage*. *USB mode: Data storage* is displayed while the phone is in data transfer mode.
3. Open Windows Explorer. Your phone microSD card will appear as a local drive (the device name), and with a drive letter assigned to it.
4. Click on the folders to display a window that shows the contents of the folder on the phone microSD card.
5. Open a second instance of Windows Explorer and display the contents of the folder on your PC where you have MP3 files, photo files, or video files stored.
6. Select the files on your PC that you wish to transfer to the phone.

7. Drag and drop the files from the second window into the first window and place in a folder.
8. The files are transferred to the phone and can be played by the *Music player* or accessed by the *Media player*.

If you selected a file or files that require more memory than can fit on the available phone memory, you will get an error note. Deselect some of your selected files until the required memory is less than or equal to the available memory on your phone.

Disable data storage connection

1. To disable the USB data cable, double-click the green arrow on the task bar at the bottom of your PC screen.
A window pops up that displays **Unplug** or **Eject Hardware**.
2. Click on USB Device in the Hardware devices window.
A popup window displays **Stop a Hardware device**.
3. Highlight **USB device**, and click **OK**.
The popup window, **Safe to Remove Hardware**, is displayed with **The 'USB Device' device can now be safely removed from the system**.
4. Click **OK**.



Important: To ensure that all memory card operations are completed in a controlled way, do not unplug the connectivity cable until Windows notifies you that it is safe to do so. Uncontrolled completion or unexpected disruptions of the memory card operations may cause the memory card and the information stored on it to become corrupted.

A corrupted memory card may have to be formatted before it can be used again. When a memory card is formatted, all information on the card is permanently lost.

headset, car kit, loopset, or charger is connected. Select *On* or *Off*.

Lights (for *Handsfree* or *Charger* only)—Choose to keep the phone lights always on, or to shut off automatically after several seconds. Select *On* or *Automatic*.

If the *Loopset* is connected and recognised through the Pop-Port™ connector, the phone automatically uses the *Loopset*.

Text phone (network service)—Connect to a TTY/TDD device. Check with the manufacturer of the TTY/TDD device for a connecting cable that is compatible with your phone. Check with your service provider for availability and description of services.

■ Enhancements

Select *Menu* > *Settings* > *Enhancements*. You can select an enhancement menu if the phone is or has been connected to a compatible enhancement type. Depending on enhancement, select from the following options:

Default profile—Choose the profile you wish to be automatically activated when a headset, car kit, or loopset is connected.

Automatic answer—Answer calls automatically after one ring when a

■ Security

PIN code

The PIN code protects the UIM card from unauthorised access. The PIN code can be 4–8 digits in length. After three successive incorrect entries, the PIN code is blocked. You need to enter the personal unblocking key (PUK) code. See “*Personal unblocking key (PUK) code*”, p. 56.



Note: The PIN code must be obtained from your wireless service provider or network operator. The PIN code is typically provided with your UIM card.

PIN code request

To provide extra security in case your phone is lost or stolen, enable your phone to request the PIN code when powered on.

1. In standby mode, select *Menu* > *Settings* > *Security* > *PIN code request*.
2. Enter the PIN code, and select *OK*.
3. Select *On*.

Call restrictions

Select call restrictions to block or allow numbers for incoming and outgoing calls. With any numbers entered as allowed numbers, all those entered as blocked numbers are ignored. With a number blocked, the phone blocks any call from it, and send the caller to the voice mail.

1. In standby mode, select *Menu* > *Settings* > *Security* > *Call restrictions*.
2. Enter the security code, and select *OK*. See "*Security*", p. 54.
3. Select the types of calls you want to restrict:

Restrict sent calls—Set restrictions on making calls.

Restrict rcvd. calls—Set restrictions on receiving calls.

4. Select whether to block or allow numbers:

Blocked numbers—Set the numbers the phone can only block, allowing all the rest.

Allowed numbers—Set the numbers the phone can only call or receive, blocking all the rest.

5. Select one of these options: *Select*, *Add restriction* (unavailable with memory full), *Edit* (unavailable with no number added), or *Delete* (unavailable with no number added).



Note: With restricted calls, you may still call the official emergency number programmed into your device.

Security level

Your device can be set to different security levels to control device use and memory settings. In standby mode, select *Menu* > *Settings* > *Security* > *Security level*. Enter your security code, and select *OK* and one of the following options:

None—Disable security level protection.

Memory—Enable or disable memory protection.

Phone—Enable or disable phone protection.

Access codes

You can change your security code and PIN code. Avoid using codes similar to emergency numbers such as 911 to prevent accidental dialling of the emergency number.

Change security code

The security code controls access to features such as the security level and is supplied with the phone. The preset code is 12345. When you change the security code, keep the new code secret and in a safe place, separate from your phone.

If you enter the wrong security code five times in succession, you will not be able to enter a code for 5 minutes, even if you power off the phone between incorrect entries.

1. In standby mode, select *Menu* > *Settings* > *Security* > *Access codes* > *Change security code*.
2. Enter the current security code (default is 12345), and select *OK*.
3. Enter the new security code (up to 10 characters), and select *OK*.
4. Enter the new security code again, and select *OK*.

Change PIN code

Before you can change your PIN code, you must enable PIN code request. See “PIN code request”, p. 55.

1. In standby mode, select *Menu* > *Settings* > *Security* > *Access codes* > *Change PIN code*.
2. Enter the current PIN code, and select *OK*.
3. Enter the new PIN code, and select *OK*.
4. Enter the new PIN code again, and select *OK*.

Voice privacy

Voice privacy is a network service. See “Network services”, p. viii. If your wireless service provider or network operator supports this feature, the voice privacy feature protects the privacy of your current phone conversation from other callers placing phone calls on your same network. In standby mode, select *Menu* > *Settings* > *Security* > *Voice privacy* > *On* or *Off*.

Personal unblocking key (PUK) code

The PUK code is used to restore a blocked PIN code. The PUK code is 8 characters in length and cannot be changed. The PUK code must be

obtained from your wireless service provider or network operator.



Important: If you enter an incorrect PUK code 10 times in succession, the UIM card is rejected and can no longer be used. You must contact your wireless service provider or network operator for a new UIM card.

■ Application settings

To change game and application settings, select *Menu > Settings > App. settings* and one of the following: *Application sounds > On*—Play sounds during an application.

Application lights > Application defined or *Default*—Play lights during an application.

Application vibration > On—Vibrate the phone during an application.

Use of vibration can aggravate injuries. Do not turn vibration on if you have any ailment in the bones or joints of your fingers, hands, wrist, or arms.

■ Network

The menu options in your device depend on your network operator's network. Check with your network operator for more information.

The *Network* menu enables you to personalise the way your device

chooses a network in which to operate while you are within or outside of your primary or home system. Your device is set to search for the most cost-effective network. If your device cannot find a preferred network, it selects a network automatically based on the option you choose in the *Network* menu.

Select *Menu > Settings > Network > Set mode > Home only, Automatic A, or Automatic B*.

■ Network services

To activate network services in your phone, select *Menu > Settings > Network services* and from the following options:

Network feature sett.—Activate network services in your phone using feature codes received from your network operator.

■ Positioning

Positioning contains settings for use with the Global Positioning System and the GPS receiver in Nokia 6275i devices. Contact your wireless service provider or network operator for help in selecting these settings. Select *Menu > Settings > Positioning* and a choice.

■ Restore factory settings

To reset some of the menu settings to their original values, select *Menu > Settings > Rest. factory sett.*. Enter the security or lock code, and select *OK*. Data items that you have entered or downloaded are not deleted (for example, entries in your contacts list are not affected).



Note: Depending on your wireless service provider or network operator, your device may request the security code (defaulted to 12345) instead of the lock code.

■ Phone details

To view the current details of your phone, select *Menu > Settings > Phone details* and one of the following options:

User details—Show current number details.

Version details—Show the hardware, software, and browser version information for the phone.

System details—Show the digital network the phone is on.

Icon details—Show the icons used.

10. Organiser



Your phone contains features to help organise your everyday life, including an alarm clock, calendar, calculator, countdown timer, and stopwatch.

■ Alarm clock

Set an alarm

The alarm clock is based on the phone clock. An alarm sounds at the time you specify, even if the phone is turned off.

1. Select *Menu > Organiser > Alarm clock > Alarm time*.
2. Enter the time for the alarm in hh:mm format, and select *OK*.
3. Select *am* or *pm* if 12-hour clock format is on.

Alarm on appears briefly in the display, and  appears in standby mode.

If you need to reset the alarm, select *Menu > Organiser > Alarm clock > Alarm time > On*.

To turn off the alarm, select *Menu > Organiser > Alarm clock > Alarm time > Off*.

Repeat alarm

You can set the alarm to repeat every day or only on certain days of the week.

1. Select *Menu > Organiser > Alarm clock > Repeat alarm > On*.
2. Check the day or days of the week you wish to repeat the alarm, and select *Mark*. Select *Unmark* to remove a day.
3. Select *Done* when you have added all desired days.

If you need to revise the days for a repeated alarm, select *Menu > Organiser > Alarm clock > Repeat alarm > Repetition days*.

If you need to stop a repeated alarm, select *Menu > Organiser > Alarm clock > Repeat alarm > Off*.

Set the alarm tone

To set which tone to play when the alarm sounds, select *Menu > Organiser > Alarm clock > Alarm tone > Standard, Radio, or Open Gallery*.

If you set your alarm to *Radio*, use an accessory that supports FM stereo.

Set the snooze time-out

You can set the *Snooze time-out* for the alarm.

Select *Menu > Organiser > Alarm clock > Snooze time-out* and a snooze time.

When the alarm sounds, your phone beeps, vibrates (if vibrate alert is on in the currently active profile), and lights up.

With the device on, select *Stop* to shut the alarm off or *Snooze* to interrupt the alarm for 10 minutes. *Snooze on* appears in the display.

If you do not press a key, the alarm stops for the snooze time-out period, then sounds again.

If you select *Stop*, the device asks whether you want to activate the phone for calls. Select *No* to switch off the device or *Yes* to make and receive calls. Do not select *Yes* when wireless phone use may cause interference or danger.

Calendar

The calendar keeps track of reminders, calls you need to make, meetings, memo, and birthdays. It can even sound an alarm for any of these events.

The default monthly view provides an overview of the selected month and weeks. You can also jump to a specific date. Any days or dates that appear in

bold font contain calendar notes such as a meeting or reminder. A short summary of notes for the day appear at the bottom of the screen.

Open calendar

Select *Menu > Organiser > Calendar*.

Scroll to move the cursor in the calendar view.

Calendar options

Select *Menu > Organiser > Calendar > Options* and one of the following:

Week view—View your calendar by weeks. To return to month view select *Back* while in the *Week view*.

Make a note—Create a note on the selected date.

Go to date—Jump to a specific date. Enter the date (for example, 15/07/2005), and select *OK*.

Go to today—Jump to the current date.

Settings—Modify the calendar settings.

Go to to-do list—Go directly to your to-do list.

Delete all notes—Delete all calendar notes. This option appears only if a calendar note has been created.

Make a calendar note

You can make a calendar note for a specific date. You can choose from five types of notes. Your phone asks for further information depending on which note you select. You can also set an alarm for your note.

1. Select *Menu > Organiser > Calendar*.
2. Scroll to the date for which you want to make a note. Scroll or select *Options > Go to date*, and select a date.
3. Select *Options > Make a note* and one of the following

Meeting—Enter the subject, and select *Save*. Enter a location, and select *Save*. Enter a start and end time. Select an alarm option.

Call—Enter the phone number, and select *Save*. Enter a name, and select *Save*. Enter a time. Select an alarm option. You can also select *Options > Search* to search your contacts.

Birthday—Enter the person's name, and select *Save*. Enter the year of birth. Select an alarm option.

Memo—Enter the subject, and select *Save*. Enter a start and end date. Select an alarm option.

Reminder—Enter the reminder, and select *Save*. Select an alarm option.

View calendar notes (day view)

You can view the calendar notes for a day.

1. Select *Menu > Organiser > Calendar*.
2. Scroll to the date you want to view or select *Options > Go to date*. Days with notes appear in bold type.
3. Select *View* to see the list of notes for that day.

To view a specific note, scroll to the note, and select *View* again. If there are no notes for that date, select *Add note* to create a new calendar note.

Options while viewing a day

When viewing the list of notes for a day, you can scroll to a note, select *Options* and one of the following:

Make a note—Create a new note for the selected date.

Delete—Delete the note.

Edit—Edit the note.

Use detail—Use a detail contained in the note.

Move—Move the note to another date on your calendar.

Repeat—Enable the note to recur on a regular basis (daily, weekly, biweekly, monthly, and yearly). *Repeat* is not available for *Birthday* note.

Go to date—Jump to another date on your calendar.

Go to today—Return to the current date.

Send note > **Send as message**, **Via calendar**, **Via infrared**, or **Via Bluetooth**—Send a calendar note in calendar format (vCal), in a text message, directly to another device.

Copy—Copy the note. You can paste the note to another date.

Settings—Modify the calendar settings.

Go to to-do list—Go directly to your to-do list.

Receive a calendar note

When you receive a calendar note in calendar-to-calendar format (vCal), your phone displays *Calendar note received*.

Select **Show** to view the calendar note. Select **Save** to save the note to your calendar or **Options** > **Discard** to discard the note.

Modify calendar settings

Select **Menu** > **Organiser** > **Calendar** > **Options** > **Settings** and one of the following:

Set the date—Enter the current date, and select **OK**. Appears only when the date has not yet been set.

Set the time—Enter the current time, and select **OK**. Appears only when the time has not yet been set.

Time zone—Select your current time zone.

Date format—Select your preferred date format.

Date separator—Select your preferred date separator.

Time format—Select your preferred time format.

Default view—Select a monthly or weekly view.

Week starts—Select the day the week starts.

Auto-delete notes—Select when to delete past notes.

Notes

You can write text notes with the **Notes**. You can also send notes using text messaging, infrared, or Bluetooth connectivity.

Select **Menu** > **Organiser** > **Notes** to see your current list of notes. If there are no notes, select **Add** to create a note. If there are existing notes, scroll to a note, and select **View**. Create your note, and select **Save**.

To write additional notes, select **Menu** > **Organiser** > **Notes** > **Options** > **Make a note**. Create your

note, select any note options, and select *Save*.

When you create a note, the following options are available:

Insert time & date—Adds the time and date to your note.

Close—Returns you to the notes list.

Insert smiley—Inserts a smiley into your message.

Insert word or *Edit word*—Enter or edit the text of a new word that might not appear in the predictive text dictionary. This option is displayed only when predictive text is on.

Insert symbol—Inserts a special character into your message.

Option only appears when predictive text is on.

Writing language—Choose the language you want to use.

Prediction on or *Prediction off*—Turn predictive text on or off.

Matches—View matches found in the predictive text dictionary for the word you want to use. This option is displayed only when predictive text is on and there is more than one possible match.

Send a note

Select *Menu > Organiser > Notes*, scroll to the note you wish to send, and select *Options > Send note > Send as message*, *Via infrared*, or *Via Bluetooth* to send the note in a text message to another device.

Notes options

Select *Menu > Organiser > Notes > Options* and one of the following:

Make a note—Create a new note.

Delete—Delete the note you selected.

Edit—Edit the note you selected.

Use detail—Use a detail contained in the note.

Send note > Send as message, *Via infrared*, or *Via Bluetooth*—Send a note in a text message, directly to another device.

Delete all notes—Delete all notes.

The note options appear only when you have created one or more notes.

■ To-do list

Use the *To-do list* feature to keep track of your tasks. You can save a task or errand as a to-do list note, select a priority level for the to-do list note, and mark it as done when you have completed it. You can sort the to-do list notes by priority or by date.

Select *Menu > Organiser > To-do list*. The current to-do list is displayed.

If there are no to-do tasks, select *Add* to create your first to-do list note.

If there are existing to-do list notes, scroll to a to-do list note, and select *View*.

Select *Menu > Organiser > To-do list > Options > Add*. Enter the subject, and select *Save > High, Medium, or Low*.

To write additional notes, select *Menu > Organiser > To-do list > Options > Add*. Enter the subject, and select *Save > High, Medium, or Low*.

When you create a to-do list note, the following options are available:

Search—Search for existing notes.

Insert smiley—Insert a smiley into your message.

Insert word or *Edit word*—Enter or edit the text of a new word that might not appear in the predictive text dictionary. These options are displayed only when predictive text is on.

Insert symbol—Insert a special character into your message. *Insert symbol* is displayed only when predictive text is on.

Writing language—Choose the language you want to use.

Prediction on or *Prediction off*—Turn predictive text on or off.

Matches—View matches found in the predictive text dictionary for the word you want to use. This option is displayed only when predictive text is on.

To edit the notes, select *Menu > Organiser > To-do list > View > Edit*. Edit the subject, select *Save*.

To view to-do list notes, select *Menu > Organiser > To-do list > View > Options*, and one of the following choices:

Deadline—Change the deadline of the to-do list note.

Mark note as done or *Mark as not done*—Indicate whether the to-do list note is completed or not.

Delete—Delete the to-do list note.

Use detail—Use a detail contained in the note.

Edit priority—Change the priority to *High, Medium, or Low*.

Send > Send as message, Via calendar, Via infrared, or Via Bluetooth—Send the to-do list note.

Go to calendar—Leave the to-do list, and go to the calendar.

Save to calendar—Save the to-do list note to your calendar.

Send a to-do list note

To send the to-do list note in calendar format (vCal), in a text message, directly to another device, select *Menu > Organiser > To-do list*, scroll to the note you wish to send, and select *Options > Send > Send as message, Via calendar, Via infrared, or Via Bluetooth*.

To-do list options

Select *Menu > Organiser > To-do list > Options* and one of the following:

Add—Create a new to-do list note.

Delete—Delete the to-do list note you selected.

Mark note as done or *Mark as not done*—Indicate whether the to-do list note is completed or not.

Use detail—Use a detail contained in the note.

Sort by deadline or *Sort by priority*—Sort the to-do list by either date or priority.

Send > Send as message, Via calendar, Via infrared, or Via Bluetooth—Send the to-do list note in calendar format (vCal) in a text message, directly to another device.

Go to calendar—Leave the to-do list, and go to the calendar.

Save to calendar—Save the to-do list note you selected to your calendar.

Delete done notes—Delete the to-do list note you selected from your calendar.

Delete all notes—Delete all the to-do list notes.

The to-do list options appear only when you have created one or more notes.

■ Calculator

The calculator in your phone adds, subtracts, multiplies, divides, calculates the square and the square root, changes the sign of the number entered, and converts currency values.



Note: This calculator has a limited accuracy and is designed for simple calculations.

To use the calculator, do the following:

1. Select *Menu > Organiser > Calculator*.
2. Enter the first number in the calculation.

Press # for a decimal point if necessary.

Press the scroll key up or down to change the sign of your number or value.

Press * to cycle through the add (+), subtract (-), multiply (*), and divide (/) characters. Pause briefly to select the displayed character.

3. Enter the second number in your calculation.

4. Select *Equals*.

To perform a square or square root calculation, select *Options > Square* or *Square root*.

■ Currency converter

You can convert foreign currency to domestic, or vice versa, directly from standby mode or from the *Calculator* menu.



Note: When you change base currency, you must enter the new rates because all previously set exchange rates are set to zero.

1. Select *Menu > Organiser > Calculator > Options > Exchange rate > Foreign units in home units* or *Home units in foreign units*.

Foreign units in home units—The number of home units it takes to make one unit of foreign currency.

Home units in foreign units—The number of foreign units it takes to make one unit of your home currency.

2. Enter the exchange rate (press # to insert a decimal), and select *OK*.

3. Select *Back* to return to the *Calculator* screen, and enter the currency amount to convert.

4. Select *Options > To home* or *To foreign*.

To home—Converts foreign currency to domestic currency.

To foreign—Converts domestic currency to foreign currency.

5. If you have not already entered an exchange rate, the device prompts you to enter it. Select *OK*. You can edit the exchange rate at any time.

■ Timers

Your device contains two event timers: a normal timer that counts down a set interval, and an interval timer that counts up set intervals.

The timers only work when the phone is on. Once you turn off your phone, the timers are no longer active.

Normal timer

This countdown timer enables you to enter a specific duration (up to 99 hours, 59 minutes, and 59 seconds).

When the time runs out, your device sounds an alarm.

To set the normal timer, do the following:

1. Select *Menu > Organiser > Timer > Normal timer*.

2. Enter the time (in hh:mm:ss format), and select *OK*.

3. Enter a note for the timer, and select *Start*.



and the timer (in hh:mm:ss format) appear in standby mode when the countdown timer is running.

When the time runs out, your phone sounds an alarm, vibrates, and flashes its lights. If you are in standby mode, select *Restart* or *Exit*. If you are not in standby mode, press any key during the alarm to stop the timer.

After 60 seconds the timer alert expires automatically. Select *Exit* or press the end key to clear the timer note.

To change the time:

1. Select *Menu > Organiser > Timer > Change time*.
2. Enter the new time, and select *OK*.
3. Leave the note as it was, or enter a new note, and select *Start*.

To stop the timer before the alarm sounds, select *Menu > Organiser > Timer > Stop timer*.

Interval timer

The interval timer in your device allows you to store multiple interval timers.

You can define and store up to 10 timing periods for each interval timer. Once at least one interval timer is set and stored, you can select the interval timer and one of the stored intervals for that timer. When the selected interval expires, your phone sounds an alarm, vibrates, and flashes its lights.

To set an interval timer, do the following:

1. Select *Menu > Organiser > Timer > Interval timer*.
2. Select *Add new timer*. This option only appears if you have already created an interval timer.
3. Enter a name for the timer, and select *Save*.
4. Enter a name for the first timer period, and select *Save*.
5. Enter the desired time interval, and select *OK*.
6. Select an existing stored period and *Edit period*, *Add period*, *Delete period*, or *Start timer*.

To use an interval timer:

1. Select *Menu > Organiser > Timer > Interval timer*, and one of the set interval timers. *Add new timer* is the only choice if you have not yet set any interval timers.
2. Select *Start timer, View timer, Edit timer, Add new timer, or Delete timer*. These options only appear if you have already created an interval timer.

■ Stopwatch

Your phone has a stopwatch that can be used to track time. The stopwatch displays time in hours, minutes, seconds, and fractions of a second in hh:mm:ss.ss format.

Using the stopwatch or allowing it to run in the background when using other features increases the demand on battery power and reduces the battery life.

Measure split or lap time

Use the split time or lap time functions for activities where you need to pace yourself. To measure split or lap times, do the following:

Split timing—Use the split time function for such activities as a long distance race when you need to pace yourself. Select *Split* to note the lapsed time. The timer continues to run and

the split time appears below the running time. Each time you select *Split*, the new measured time appears at the beginning of the list.

The maximum number of splits is 20.

Lap timing—Use the lap time function when you want to track how long it takes to complete each cycle or lap. Select *Lap* to note the lap time. The clock stops, then immediately restarts from zero. The lap time appears below the running time. Each time you select *Lap*, the new measured time appears at the beginning of the list. The maximum number of laps is 20.

1. Select *Menu > Organiser > Stopwatch > Split timing or Lap timing > Start*.
2. Select *Stop* to end timing and display total time.

Save a time

To save a time while the clock is running, select *Stop > Save*, enter a name for the measurement, and select *OK*. If you do not enter a name, the total time is used as the default title for the lap or split time.

Stopwatch options

Select *Menu > Organiser > Stopwatch* and one of the following:

Continue—Continue to measure time and return to the stopwatch screen. This option appears only if the clock is running.

Show last time—View the last measured time.

Split timing—Use the split time function.

Lap timing—Use the lap time function.

View times—Browse saved times.

Delete times > One by one or *Delete all*—Delete saved times.

Stop—Stop the clock.

Operation note

If you press the end key and return to standby mode, the clock continues to run in the background, and  appears at the top of the screen.

11. Minibrowser



Minibrowser is a network service. See "Network services", p. viii.

Your phone has a built-in browser you can use to connect to selected services on the mobile internet. If your wireless service provider or network operator supports this feature, you can view weather reports, check news or flight times, view financial information, and much more. The web browser on your phone can display WAP-based content.

Your device may have some bookmarks loaded for sites not affiliated with Nokia. Nokia does not warrant or endorse these sites. If you choose to access them, you should take the same precautions, for security or content, as you would with any internet site.

If the security indicator () is displayed during a connection, the data transmission between the device and the internet gateway or server is encrypted. The service provider secures the data transmission between the gateway and the content server.



Important: Use only services that you trust and that offer adequate security and protection against harmful software.

■ Mobile internet access

Because mobile internet content is designed to be viewed from your phone, your wireless provider is now your mobile internet service provider as well.

Your wireless provider has created a home page and set up your browser to go to this page when you log on to the mobile internet. Once at your service provider's home page, you may find links to a number of other sites.

It should not be necessary to manually configure the browser on your phone. Normally this is done by your wireless provider when you subscribe to the feature. Contact your wireless provider if you have problems using the browser.

■ Sign on to the mobile internet

Select *Menu > Minibrowser*.

After a brief pause, your phone attempts to connect to your wireless provider's home page. If you receive an error message, your phone may not be set up for browsing. Contact your wireless provider to make sure that your phone is configured properly.

■ Navigate the mobile internet

Since your phone screen is much smaller than a computer screen, mobile internet content is displayed differently than you may be accustomed to seeing. This section contains guidelines for using phone keys to navigate a WAP site.

Phone keys

- To browse the WAP site, scroll up or down.
- Select a highlighted item.
- To enter text, press # to switch text input modes, and press 0-9.
- To enter special characters, press *.

Receive a call while online

Depending on your wireless service provider or network operator, you may still be able to receive a voice call while using the WAP browser.

- To answer the incoming call, press the call key.
- To reject the incoming call, press the end key.

After you end your voice call, the mobile internet connection automatically resumes.

If your wireless service provider or network operator does not support incoming calls while browsing, incoming calls are automatically forwarded to voice mail.

Make an emergency call while online

You can end your data connection and make an emergency call.

1. To close your mobile internet connection, press the end key.
2. Press the end key as many times as needed to clear the display and ready the phone for calls.
3. Enter the emergency number for your present location (for example, 911). Emergency numbers vary by location.
4. Press the call key.

Clear the cache and disconnect

A cache is a memory location that is used to store data temporarily. If you have tried to access or have accessed confidential information requiring passwords, empty the cache after each use. The information or services you have accessed are stored in the cache.

To empty the cache while in the browser menu, select **Navigate > Advanced > Clear**. Scroll to the cache and select **Cache > Clear**. The cache also clears when you press and hold the end key to power off your device.

To close your mobile internet connection while browsing, press the end key.

12. Extras



Your wireless provider may provide extra features in the *Extras* menu.

■ Memory card

To manage the content of your microSD card, select *Menu > Extras > Memory card > Options > Type of view, Sort, Application settings, Add folder, Memory status, or Activation key list.*

■ Games

Depending on your service provider, games and other applications may be preloaded on your phone. Select *Menu > Extras > Games* to display the games. Select *Menu > Extras > Games > Options* to manage your games. Select *Options > Memory status* to view the memory available for game installations.

■ Collection

Your phone software includes some Java applications specially designed for this Nokia phone.

Launch an application

Select *Menu > Extras > Collection*. Scroll to an application, and select *Open*, or press the call key.

An application may require a few seconds to load. When you open an application, wait for the launch screen to disappear. At that point, the application is ready.

Leaving applications running in the background increases the demand on battery power and reduces the battery life.

To view the memory available for application installations, select *Menu > Extras > Collection > Options > Memory status.*



Note: Only install applications from sources that offer adequate protection against harmful software.

13. PC connectivity

■ PC data transfer

You can transfer data, such as music, photos, and videos, from your device to a compatible PC or from a compatible PC to your device using Bluetooth connectivity. See "[Bluetooth connectivity](#)", p. 49.

You can transfer data, such as music, photos, and videos, from your device to a compatible PC or from a compatible PC to your device using an IR connection. See "[Infrared connectivity](#)", p. 52.

Remember to make back-up copies of all important data.

Some of the features in your phone require network support. Contact your service provider for availability and configuration instructions.

■ Nokia PC Suite

Nokia PC Suite software is available for this phone. Nokia PC Suite is a collection of powerful tools that you can use to manage your phone features and data. Each component is a separate program that includes online helps.

Nokia PC Suite software, installation instructions, and other documentation is provided free of charge and can be downloaded from the software downloads of the Nokia web site: www.nokia-asia.com/pcsuite.

14. Enhancements



Check the model number of any charger before use with this device. This device is intended for use when supplied with power from the AC-3 or AC-4 charger.



Warning: Use only batteries, chargers and enhancements approved by Nokia for use with this particular model. The use of any other types may invalidate any approval or warranty, and may be dangerous.

For availability of approved enhancements, please check with your dealer. When you disconnect the power cord of any enhancement, grasp and pull the plug, not the cord

A few practical rules about accessories and enhancements:

- Keep all accessories and enhancements out of the reach of small children.
- When you disconnect the power cord of any accessory or enhancement, grasp and pull the plug, not the cord.
- Check regularly that enhancements installed in a vehicle are mounted and are operating properly.
- Installation of any complex car enhancements must be made by qualified personnel only.

Power

- Standard Li-ion Battery (BL-6C)
- Compact Charger (AC-3)
- Travel Charger (AC-4)
- Compact Travel Charger (AC-5)
- Mobile Charger (DC-4)
- Charger Adapter (CA-44)

Use the CA-44 charger adapter to connect the phone with Nokia chargers with a larger barrel size, including ACP-7, ACP-8, ACP-9, ACP-12, AC-1 (retractable charger), and LCH-12 (mobile charger).

USB data cable

- Connectivity Cable (CA-53)

Handsfree car solutions

- Wireless plug-in Car Handsfree (HF-6W)

Enhancements

- Easy-to-use Plug-in Car Handsfree (HF-3)
- Wireless Plug-in Car Handsfree (HF-33W)
- Advanced Car Kit (CK-7Wi)
- Advanced Car Kit (CK-20W)
- Mobile Holder (CR39)

Headsets

- Mono Headsets (HDB-4, HS-5, HS-8)
- Stereo Headsets (HS-3, HS-23, HS-31, HS-49)
- Wireless Headsets (HS-24W (BH800), HS25W (BH900), HS-26W, HS36W, HS-50W, HS-57W (BH700), HS-58W (BH200))

Miscellaneous

- Inductive Loopset (LPS-4)
- DT-14
- TTY Adapter (HDA-10)
- Audio Adapter (AD-46)
- Music Stand (MD-1)
- Micro SD Memory

15. Battery information

■ Charging and discharging

Your device is powered by a rechargeable battery. The full performance of a new battery is achieved only after two or three complete charge and discharge cycles. The battery can be charged and discharged hundreds of times, but it will eventually wear out. When the talk and standby times are noticeably shorter than normal, replace the battery. Use only Nokia approved batteries, and recharge your battery only with Nokia approved chargers designated for this device.

If a replacement battery is being used for the first time or if the battery has not been used for a prolonged period, it may be necessary to connect the charger then disconnect and reconnect it to begin charging the battery.

Unplug the charger from the electrical plug and the device when not in use. Do not leave a fully charged battery connected to a charger, since overcharging may shorten its lifetime. If left unused, a fully charged battery will lose its charge over time.

If the battery is completely discharged, it may take a few minutes before the charging indicator appears on the

display or before any calls can be made.

Use the battery only for its intended purpose. Never use any charger or battery that is damaged.

Do not short-circuit the battery. Accidental short-circuiting can occur when a metallic object such as a coin, clip, or pen causes direct connection of the positive (+) and negative (-) terminals of the battery. (These look like metal strips on the battery.) This might happen, for example, when you carry a spare battery in your pocket or purse. Short-circuiting the terminals may damage the battery or the connecting object.

Leaving the battery in hot or cold places, such as in a closed car in summer or winter conditions, will reduce the capacity and lifetime of the battery. Always try to keep the battery between 15°C and 25°C (59°F and 77°F). A device with a hot or cold battery may not work temporarily, even when the battery is fully charged. Battery performance is particularly limited in temperatures well below freezing.

Do not dispose of batteries in a fire as they may explode. Batteries may also explode if damaged. Dispose of

batteries according to local regulations. Please recycle when possible. Do not dispose as household waste.

■ Nokia battery authentication guidelines

Always use original Nokia batteries for your safety. To check that you are getting an original Nokia battery, purchase it from an authorised Nokia dealer, look for the Nokia Original Enhancements logo on the packaging and inspect the hologram label using the following steps:

Successful completion of the four steps is not a total assurance of the authenticity of the battery. If you have any reason to believe that your battery is not an authentic original Nokia battery, you should refrain from using it, and take it to the nearest authorised Nokia service point or dealer for assistance. Your authorised Nokia service point or dealer will inspect the battery for authenticity. If authenticity cannot be verified, return the battery to the place of purchase.

Authenticate hologram

1. When looking at the hologram on the label, you should see the Nokia connecting hands symbol from one

angle and the Nokia Original Enhancements logo when looking from another angle.



2. When you angle the hologram left, right, down, and up, you should see 1, 2, 3, and 4 dots on each side respectively.

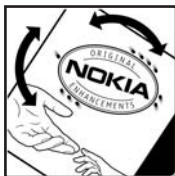

3. Scratch the side of the label to reveal a 20-digit code, for example, 12345678919876543210. Turn the battery so that the numbers are facing upwards. The 20-digit code reads starting from the number at the top row followed by the bottom row.



4. Confirm that the 20-digit code is valid by following the instructions at www.nokiaoriginals.com/check.



To create a text message enter the 20-digit code, for example, 12345678919876543210, and send to +44 7786 200276.

To create a text message,

- For countries in Asia Pacific, excluding India: Enter the 20-digit code, for example, 12345678919876543210, and send to +61 427151515.
- For India only: Enter Battery followed by the 20-digit battery code, for example, Battery 12345678919876543210, and send to 5555.

National and international operator charges will apply.

You should receive a message indicating whether the code can be authenticated.

If you need assistance confirming the battery code, contact your local Nokia Care Centres listed at www.nokia-asia.com/carecentrelocator.

What if your battery is not authentic?

If you cannot confirm that your Nokia battery with the hologram on the label is an authentic Nokia battery, please do not use the battery. Take it to the nearest authorised Nokia service point or dealer for assistance. The use of a battery that is not approved by the manufacturer may be dangerous and may result in poor performance and damage to your device and its enhancements. It may also invalidate any approval or warranty applying to the device.

To find out more about original Nokia batteries, visit www.nokiaoriginals.com/battery.

16. Care and maintenance

Your device is a product of superior design and craftsmanship and should be treated with care. The suggestions below will help you protect your warranty coverage.

- Keep the device dry. Precipitation, humidity, and all types of liquids or moisture can contain minerals that will corrode electronic circuits. If your device does get wet, remove the battery, and allow the device to dry completely before replacing it.
- Do not attempt to remove the battery from the device. Nokia recommends that you take the device to the nearest authorised service facility for replacement of the battery.
- Do not use or store the device in dusty, dirty areas. Its moving parts and electronic components can be damaged.
- Do not store the device in hot areas. High temperatures can shorten the life of electronic devices, damage batteries, and warp or melt certain plastics.
- Do not store the device in cold areas. When the device returns to its normal temperature, moisture can form inside the device and damage electronic circuit boards.
- Do not attempt to open the device other than as instructed in this guide.
- Do not drop, knock, or shake the device. Rough handling can break internal circuit boards and fine mechanics.
- Do not use harsh chemicals, cleaning solvents, or strong detergents to clean the device.
- Do not paint the device. Paint can clog the moving parts and prevent proper operation.
- Use a soft, clean, dry cloth to clean any lenses, such as camera, proximity sensor, and light sensor lenses.
- Use only the supplied or an approved replacement antenna. Unauthorised antennas, modifications, or attachments could damage the device and may violate regulations governing radio devices.
- Use chargers indoors.
- Always create a backup of data you want to keep, such as contacts and calendar notes, before sending your device to a service facility.

All of the above suggestions apply equally to your device, battery, charger, or any enhancement. If any device is not working properly, take it to the nearest authorised service facility for service.

17. Additional safety information

■ Operating environment

Your device and its enhancements may contain small parts. Keep them out of the reach of small children.

Remember to follow any special regulations in force in any area and always switch off your device when its use is prohibited or when it may cause interference or danger. Use the device only in its normal operating positions. This device meets RF exposure guidelines when used either in the normal use position against the ear or when positioned at least 2.2 centimeters (7/8 inch) away from the body. When a carry case, belt clip, or holder is used for body-worn operation, it should not contain metal and should position the device the above-stated distance from your body. To transmit data files or messages, this device requires a quality connection to the network. In some cases, transmission of data files or messages may be delayed until such a connection is available. Ensure the above separation distance instructions are followed until the transmission is completed.

■ Medical devices

Operation of any radio transmitting equipment, including wireless phones, may interfere with the functionality of inadequately protected medical devices. Consult a physician or the manufacturer of the medical device to determine if they are adequately shielded from external RF energy or if you have any questions. Switch off your device in health care facilities when any regulations posted in these areas instruct you to do so. Hospitals or health care facilities may be using equipment that could be sensitive to external RF energy.

Pacemakers

Pacemaker manufacturers recommend that a minimum separation of 15.3 centimeters (6 inches) be maintained between a wireless device or phone and a pacemaker to avoid potential interference with the pacemaker. These recommendations are consistent with the independent research by and recommendations of Wireless Technology Research. To minimise the potential for interference, persons with pacemakers should do the following:

- Always keep the device more than 15.3 centimeters (6 inches) from their pacemaker when the device is switched on

- Not carry the device in a breast pocket
- Hold the device to the ear opposite the pacemaker to minimise the potential for interference.

If you have any reason to suspect that interference is taking place, switch off your device immediately.

Hearing aids

Some digital wireless devices may interfere with some hearing aids. If interference occurs, consult your network operator.

■ Vehicles

RF signals may affect improperly installed or inadequately shielded electronic systems in motor vehicles such as electronic fuel injection systems, electronic antiskid (antilock) braking systems, electronic speed control systems, and air bag systems. For more information, check with the manufacturer or its representative of your vehicle or any equipment that has been added.

Only qualified personnel should service the device, or install the device in a vehicle. Faulty installation or service may be dangerous and may invalidate any warranty that may apply to the device. Check regularly that all wireless device equipment in your vehicle is mounted and operating properly. Do not store or carry flammable liquids, gases, or explosive materials in the same compartment as the device, its parts, or enhancements.

For vehicles equipped with an air bag, remember that air bags inflate with great force. Do not place objects, including installed or portable wireless equipment in the area over the air bag or in the air bag deployment area. If in-vehicle wireless equipment is improperly installed and the air bag inflates, serious injury could result.

Using your device while flying in aircraft is prohibited. Switch off your device before boarding an aircraft. The use of wireless teledevices in an aircraft may be dangerous to the operation of the aircraft, disrupt the wireless telephone network, and may be illegal.

■ Potentially explosive environments

Switch off your device when in any area with a potentially explosive atmosphere and obey all signs and instructions. Potentially explosive atmospheres include areas where you would normally be advised to turn off your vehicle engine. Sparks in such areas could cause an explosion or fire resulting in bodily injury or even death. Switch off the device at refuelling points such as near gas pumps at service stations. Observe restrictions on the use of radio equipment in fuel depots, storage, and distribution areas; chemical plants; or where blasting operations are in progress. Areas with a potentially explosive atmosphere are often but not always clearly marked. They include below deck on boats,

chemical transfer or storage facilities, vehicles using liquefied petroleum gas (such as propane or butane), and areas where the air contains chemicals or particles such as grain, dust, or metal powders.

Failure to observe these instructions may lead to suspension or denial of telephone services to the offender, legal action, or both.

■ Emergency calls



Important: Wireless phones, including this device, operate using radio signals, wireless networks, landline networks, and user-programmed functions. Because of this, connections in all conditions cannot be guaranteed. You should never rely solely on any wireless device for essential communications like medical emergencies.

To make an emergency call, make sure your device is properly charged before attempting any emergency calls. If your battery becomes empty, you cannot receive or make calls, including emergency calls and must wait a few minutes after the charging begins to place your call.

1. If the device is not on, switch it on. Check for adequate signal strength. Some networks may require that a valid UIM (CDMA SIM) card is properly inserted in the device.
2. Press the end key as many times as needed to clear the display and ready the device for calls.
3. Enter the official emergency number for your present location, and press the call key. Emergency numbers vary by location.

If certain features are in use, you may first need to turn those features off before you can make an emergency call. If the device is in an offline or flight mode you must change the profile to activate the device function before you can make an emergency call. Consult this guide or your network operator. When making an emergency call, give all the necessary information as accurately as possible. Your wireless device may be the only means of communication at the scene of an accident. Do not end the call until given permission to do so.

■ Certification information (SAR)

THIS DEVICE MEETS INTERNATIONAL GUIDELINES FOR EXPOSURE TO RADIO WAVES

Your mobile device is a radio transmitter and receiver. It is designed and manufactured not to exceed the limits for exposure to radio frequency (RF) recommended by international guidelines (ICNIRP). These limits are part of comprehensive guidelines and establish permitted levels of RF energy for the general population. The guidelines were developed by

independent scientific organisations through periodic and thorough evaluation of scientific studies. The guidelines include a substantial safety margin designed to assure the safety of all persons, regardless of age and health.

The exposure standard for mobile devices employs a unit of measurement known as the Specific Absorption Rate, or SAR. The SAR limit stated in the international guidelines is 2.0 watts/kilogram (W/kg)*. Tests for SAR are conducted using standard operating positions with the device transmitting at its highest certified power level in all tested frequency bands. Although the SAR is determined at the highest certified power level, the actual SAR of the device while operating can be well below the maximum value. This is because the device is designed to operate at multiple power levels so as to use only the power required to reach the network. In general, the closer you are to a base station, the lower the power output of the device.

The highest SAR value for this device when tested for use at the ear is 0.67 W/kg.

SAR values may vary depending on national reporting and testing requirements and the network band. Use of device accessories and enhancements may result in different SAR values. Additional SAR information may be provided under

product information at www.nokia-asia.com.

* The SAR limit for mobile devices used by the public is 2.0 W/kg averaged over 10 grams of body tissue. The guidelines incorporate a substantial margin of safety to give additional protection for the public and to account for any variations in measurements. SAR values may vary depending on national reporting requirements and the network band. For SAR information in other regions, please look under product information at www.nokia.com.

■ Battery information

This section provides information about battery charging times with the Compact Charger (AC-3), the Travel Charger (AC-4), talk, and standby times. Be aware that the information in this section is subject to change. For more information, contact your service provider.

Charging times

The following charging times are approximate with the BL-6C Li-ion battery:

Travel Charger (AC-4): up to 1 hour 45 minutes

Compact Charger (AC-3): up to 3 hours

Talk and standby times

Operation times are estimates only and depend on signal strength, phone use, network conditions, features used, battery age and condition (including charging habits), temperatures to which the battery is exposed, and many other factors.

Talk time: 3 to 4 hours (digital)

Standby time: 6 to 10 days

Index

A

- About your device vii
- Access codes 56
- Alarm clock 59
 - repeating 59
- Antenna 5
- Application settings 57
- Applications
 - collection 73
- Authenticate hologram 78
- Automate voicemail 21
- Automatic redial 43

B

- Back cover
 - remove 6
 - replace 8
- Backlight time-out 41
- Batteries and chargers 77
- Battery 6, 84
 - charge 9
 - charging times 84
 - information 77
 - remove, replace 6
 - talk and standby times 85
- Bluetooth connectivity 49
 - receive data 51
 - set up 51
 - settings 50
- Business cards 31

C

- Calendar
 - make notes 61
 - open 60
 - options 60
 - receive, send notes 62
 - settings 62
 - view 61
- Call
 - answer or reject 10
 - duration 25
- Call register 24

- Call restrictions 55
- Call settings 43
- Call waiting 11
- Caller groups 28
- Calling cards 44
- Calls
 - conference 11
 - duration 25
 - make 10
 - mute phone during 11
 - options during 11
- Camera 35
 - changing options 35
 - take photos 35
- Care and maintenance 80
- Certification information (SAR) 83
- Charger
 - connect 9
 - information 77
 - times 84
- Collection applications 73
- Conference calls 11
- Connectivity
 - phone 48
- Contacts list 27
 - add 27
 - delete 31
 - edit 30
 - send 31
 - view 31
- Countdown timer 66
- Currency converter 66

D

- Data
 - call duration 25
 - transfer 74
- Data cable transfer 52
- Data or fax calls 45
- Date setting 43
- Dialled numbers 24
- Dialling codes 22
- Display
 - main menu 3
 - settings 41

Display language 46
DTMF tones 46

E

Emergency calls 71, 83
 with keypad locked 46
Enhancements 54
 approved 75
Equaliser 39
ESN x
Extras 73

F

Fax calls 25
File transfer 53
Folders 33
Font colour 41

G

Gallery 33
Games 73
Go to functions 3

H

Headset
 connect 9
Help
 get x
 in-phone 4
 text activation 4
Help text 47

I

Indicators and icons 2
Infrared 52
Infrared connectivity 52
International prefix 45
Internet, see wireless internet
Interval timer 67
IR 52

K

Keypad
 automatic 46
 lock and unlock 12

L

Languages 46
Lap time 68
Log 24
Logs
 clearing 25
 dialled numbers 24
 missed calls 24
 received calls 24

M

Main menu display 3
Make calls 10
Media 35
Media player 36
MEID x
Memory 46
Memory card 73
Message folders 18
Messages
 delete 19
 minibrowser messages 23
 text messages 16
 voice messages 21
MicroSD card 7, 73
Minibrowser 70
 call duration 26
Minibrowser messages 23
Missed calls 24
Music player 36
Mute phone 11

N

Navigation key 46
Network
 approved for ix
 services viii, 57
 settings 57
Network services viii
Nokia battery authentication
 guidelines 78
Nokia PC Suite 74
Nokia support and contact
 information x
Notes 62
 options 63
 send 63

O

Organiser 59

P

PC connectivity 74

Personal unblocking key 56

Phone

details 58

keys and parts 1

menus 2

set up your 5

Phone connectivity 48

Phone settings 46

Photographs 35

PIN codes 54

change 56

Play

music tracks 37

radio 38

Positioning 57

Predictive text 13

PUK codes 56

Q

Quick keys 2

R

Radio 37

Received calls 24

Recording sound 39

Repeating alarm 59

Restore factory settings 58

S

Safety

important safety information 81

Safety information vii

battery 84

Screen saver 41

Scroll method 3

Security codes

change 56

Security level 55

Security settings 54

Set

time 42

Settings 40

Shared memory ix

Snooze time-out 60

Speed dials 28, 43

Split time 68

Standard mode 13

Standby mode 2

settings 41

Standby time 85

Start-up tone 47

Stopwatch 68

T

Talk time 85

Text entry 13

predictive text 13

standard 13

Text messages 16

Themes 42

Time and date settings 42

Timed profiles 40

Timer

countdown 66

interval 67

Timers 66

To-do list

options 65

send 65

Tone settings 42

Transfer files 53

Turn phone on or off 9

U

UIM card installation 7

V

Video

record 35

View

saved messages 18

Voice dialling 29, 47

Voice mail 21

Voice messages 21

Voice privacy 56

Voice recorder 39

Volume

adjust 10

Volume control 10

W

Wallpaper 41

Wireless internet

make emergency call while online

71

Writing language 46

Nokia Care Online

INTERACTIVE DEMONSTRATIONS



The Nokia Care web support provides you with more information on our online services.

INTERACTIVE DEMONSTRATIONS

Learn how to set up your phone for the first time, and find out more about its features. Interactive Demonstrations give step-by-step instructions on using your phone.

SOFTWARE



USER'S GUIDE

The online User's Guide contains detailed information on your phone. Remember to check regularly for updates.

SOFTWARE

Make the most of your phone with software for your phone and PC. Nokia PC Suite connects your phone and PC so you can manage your calendar, contacts, music and images, while other applications complement its use.

USER'S GUIDE



SETTINGS

SETTINGS

Certain phone functions, such as multimedia messaging, mobile browsing and email*, may require settings before you can use them. Have them sent to your phone free of charge.

*Not available on all phones.

HOW DO I USE MY PHONE?

The Set Up section, at www.nokia-asia.com/setup, helps you prepare your phone for use. Familiarise yourself with phone functions and features by referring to the Guides and Demos section at www.nokia-asia.com/guides.

HOW DO I SYNCHRONISE MY PHONE AND PC?

Connecting your phone to a compatible PC with the requisite Nokia PC Suite version from www.nokia-asia.com/pcsuite lets you synchronise your calendar and contacts.

WHERE CAN I GET SOFTWARE FOR MY PHONE?

Get more out of your phone with downloads from the Software section at www.nokia-asia.com/software.

WHERE CAN I FIND ANSWERS TO COMMON QUESTIONS?

Look up the FAQ section at www.nokia-asia.com/faq for answers to your questions on your phone and other Nokia products and services.

HOW DO I KEEP UP WITH NOKIA NEWS?

Subscribe online to Nokia Connections at www.nokia-asia.com/signup, and be the first to know about the latest products, promotions and upcoming events.

Should you still require further assistance, please refer to www.nokia-asia.com/contactus.

For additional information on repair services, please visit www.nokia-asia.com/repair.

Please visit www.nokia-asia.com/support for details.

NOKIA

Care